

APPENDIX B

ROOM DIAGRAMS

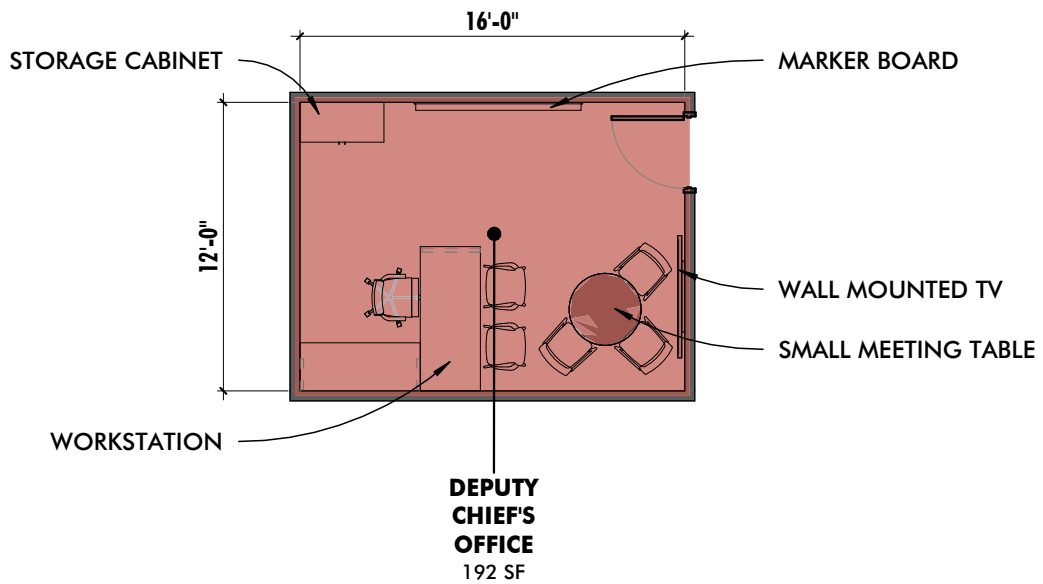

DEPUTY CHIEF'S OFFICE

BALTIMORE CITY FIRE DEPARTMENT

COPPIN STATE PUBLIC SAFETY BUILDING



10839-D PHILADELPHIA RD
WHITE MARSH, MD 21162

410-344-1460
INFO@MWSARCH.COM
WWW.MWSARCH.COM

JOB NO:22-002

DWG ISSUED ON:
09/27/2022

DWG SCALE:
1/8" = 1'-0"

DWG NUMBER:
FPR-001

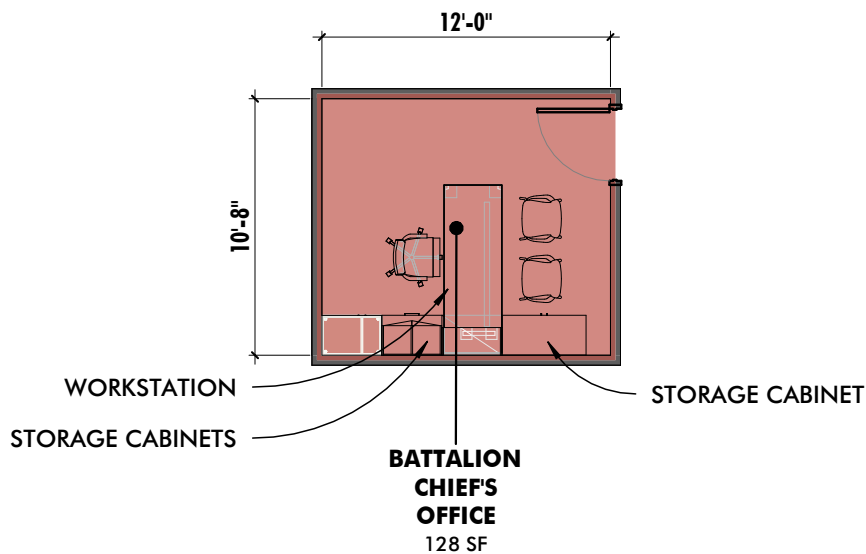

BATTALION CHIEF'S OFFICE
BALTIMORE CITY FIRE DEPARTMENT
COPPIN STATE PUBLIC SAFETY BUILDING



10839-D PHILADELPHIA RD
 WHITE MARSH, MD 21162
 410-344-1460
 INFO@MWSARCH.COM
 WWW.MWSARCH.COM

JOB NO:22-002
 DWG ISSUED ON:
09/27/2022
 DWG SCALE:
1/8" = 1'-0"
 DWG NUMBER:
FPR-002

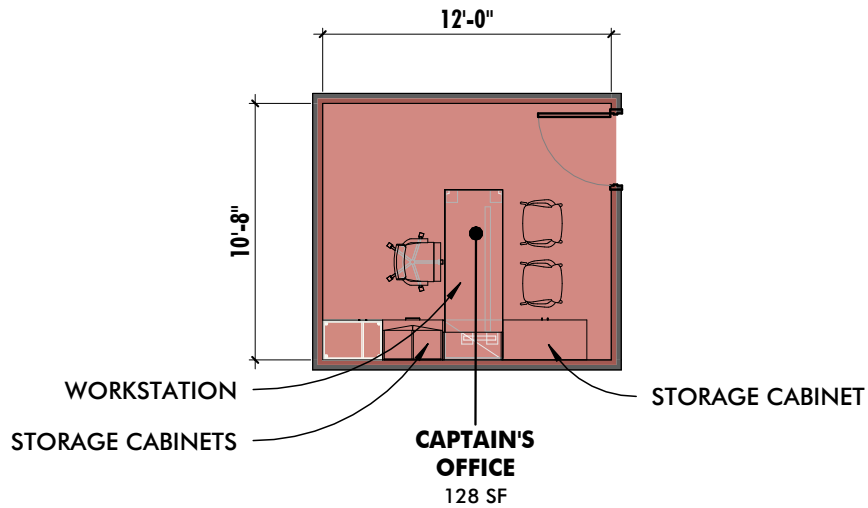

CAPTAIN'S OFFICE

BALTIMORE CITY FIRE DEPARTMENT

COPPIN STATE PUBLIC SAFETY BUILDING



10839-D PHILADELPHIA RD
WHITE MARSH, MD 21162

410-344-1460
INFO@MWSARCH.COM
WWW.MWSARCH.COM

JOB NO:22-002

DWG ISSUED ON:
09/27/2022

DWG SCALE:
1/8" = 1'-0"

DWG NUMBER:
FPR-003

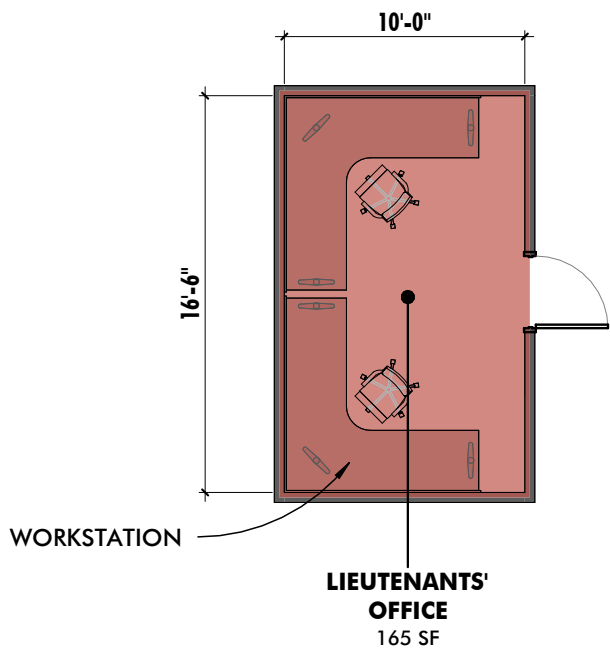

LIEUTENANTS' OFFICE

BALTIMORE CITY FIRE DEPARTMENT

COPPIN STATE PUBLIC SAFETY BUILDING



10839-D PHILADELPHIA RD
WHITE MARSH, MD 21162

410-344-1460
INFO@MWSARCH.COM
WWW.MWSARCH.COM

JOB NO:22-002

DWG ISSUED ON:
09/27/2022

DWG SCALE:
1/8" = 1'-0"

DWG NUMBER:
FPR-004

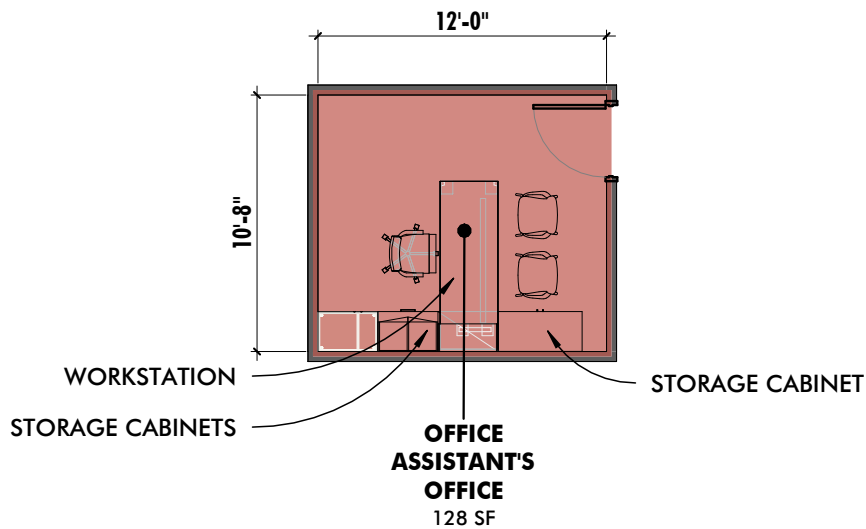

OFFICE ASSISTANT'S OFFICE

BALTIMORE CITY FIRE DEPARTMENT

COPPIN STATE PUBLIC SAFETY BUILDING



10839-D PHILADELPHIA RD
WHITE MARSH, MD 21162

410-344-1460
INFO@MWSARCH.COM
WWW.MWSARCH.COM

JOB NO:22-002

DWG ISSUED ON:
09/27/2022

DWG SCALE:
1/8" = 1'-0"

DWG NUMBER:
FPR-005

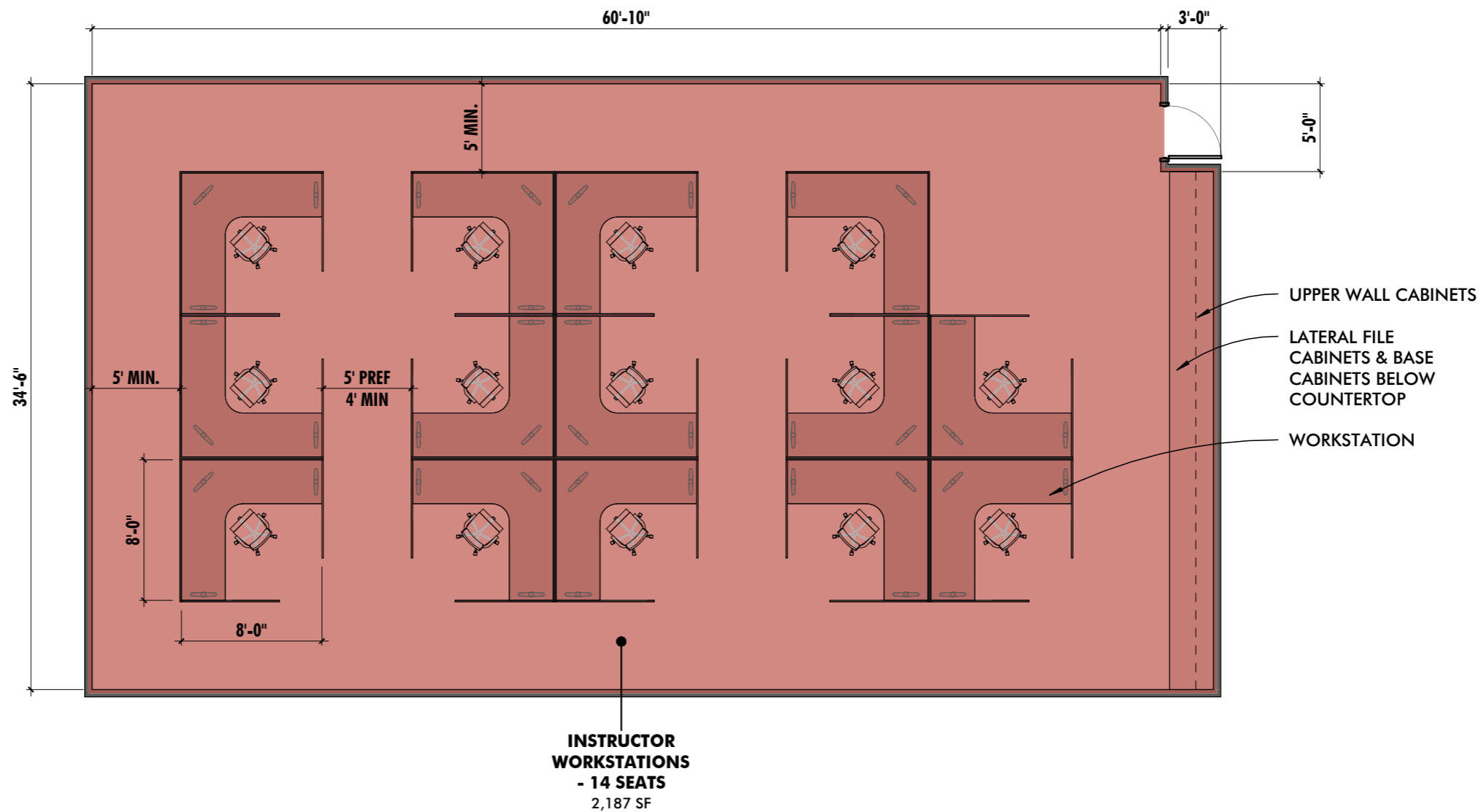

INSTRUCTOR WORKSTATIONS
BALTIMORE CITY FIRE DEPARTMENT
COPPIN STATE PUBLIC SAFETY BUILDING



10839-D PHILADELPHIA RD
WHITE MARSH, MD 21162
410-344-1460
INFO@MWSARCH.COM
WWW.MWSARCH.COM

JOB NO:22-002

DWG ISSUED ON:
09/27/2022

DWG SCALE:
1/8" = 1'-0"

DWG NUMBER:
FPR-006

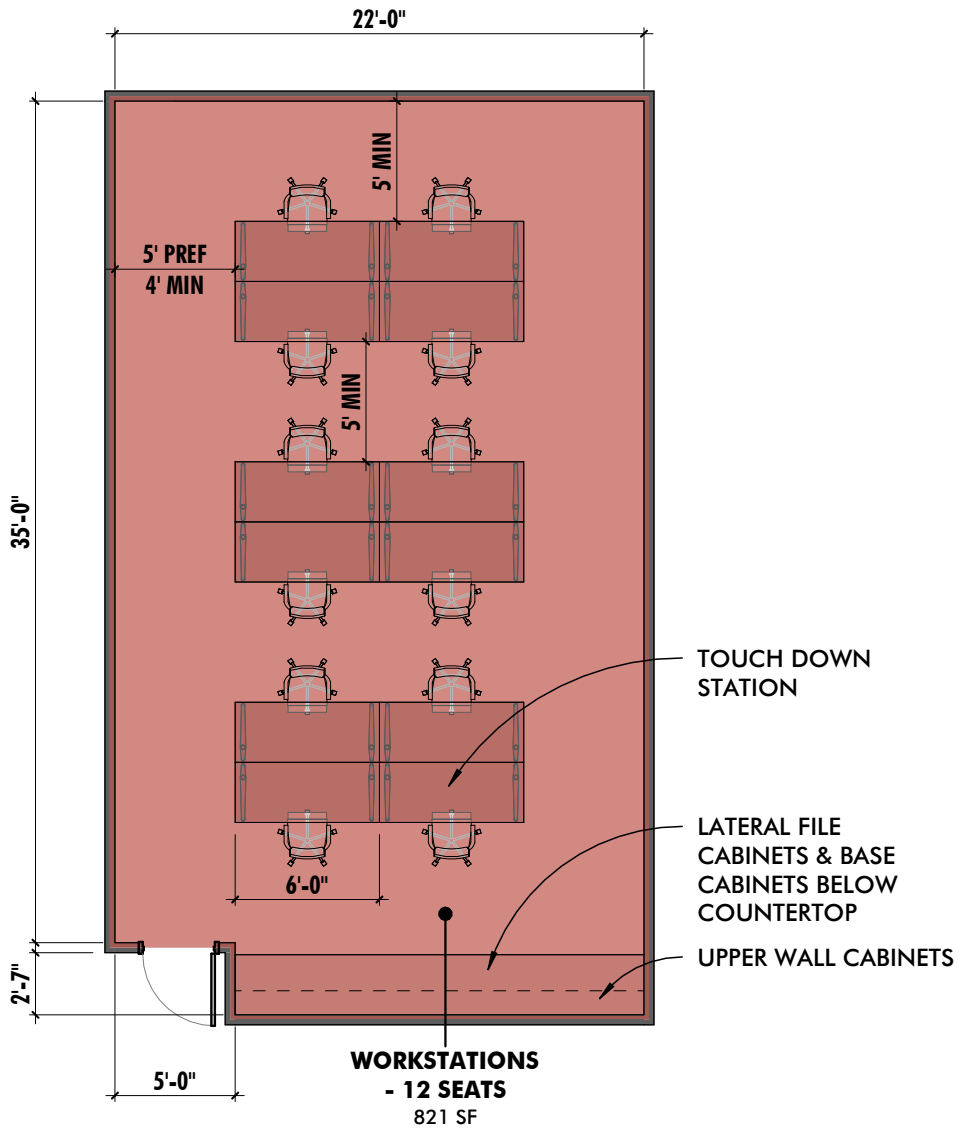

WORKSTATIONS

BALTIMORE CITY FIRE DEPARTMENT

COPPIN STATE PUBLIC SAFETY BUILDING



10839-D PHILADELPHIA RD
WHITE MARSH, MD 21162

410-344-1460
INFO@MWSARCH.COM
WWW.MWSARCH.COM

JOB NO:22-002

DWG ISSUED ON:
09/27/2022

DWG SCALE:
1/8" = 1'-0"

DWG NUMBER:
FPR-007

9/27/2022 7:40:03 AM

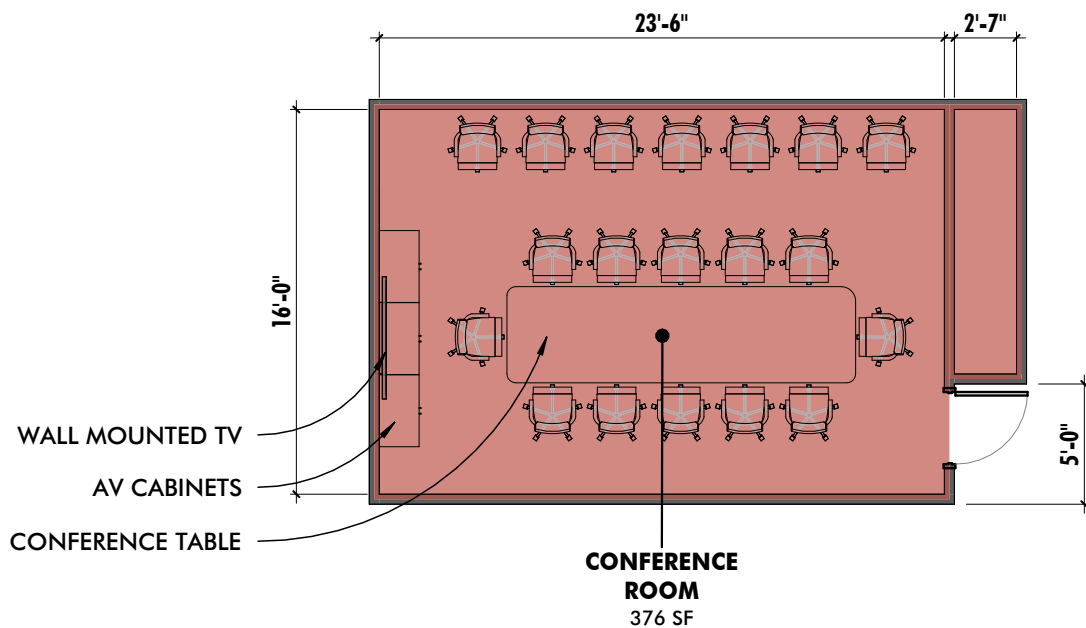

CONFERENCE ROOM

BALTIMORE CITY FIRE DEPARTMENT

COPPIN STATE PUBLIC SAFETY BUILDING



10839-D PHILADELPHIA RD
WHITE MARSH, MD 21162

410-344-1460
INFO@MWSARCH.COM
WWW.MWSARCH.COM

JOB NO:22-002

DWG ISSUED ON:
09/27/2022

DWG SCALE:
1/8" = 1'-0"

DWG NUMBER:
FPR-018

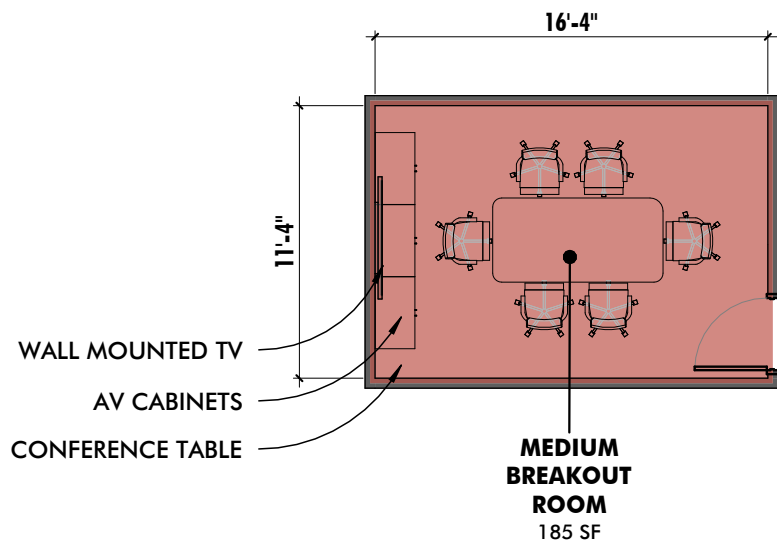

MEDIUM BREAKOUT ROOM

BALTIMORE CITY FIRE DEPARTMENT

COPPIN STATE PUBLIC SAFETY BUILDING



10839-D PHILADELPHIA RD
WHITE MARSH, MD 21162

410-344-1460
INFO@MWSARCH.COM
WWW.MWSARCH.COM

JOB NO:22-002

DWG ISSUED ON:
09/27/2022

DWG SCALE:
1/8" = 1'-0"

DWG NUMBER:
FPR-019

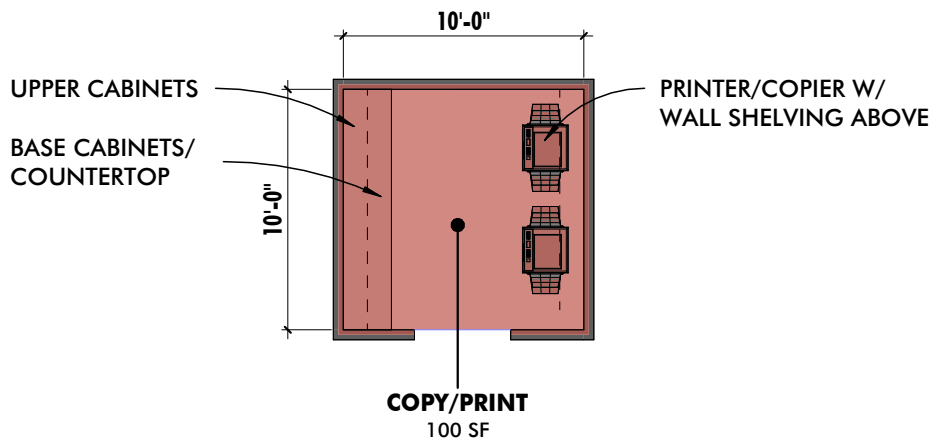

COPY/PRINT

**BALTIMORE CITY FIRE DEPARTMENT
COPPIN STATE PUBLIC SAFETY BUILDING**



10839-D PHILADELPHIA RD
WHITE MARSH, MD 21162

410-344-1460
INFO@MWSARCH.COM
WWW.MWSARCH.COM

JOB NO:22-002

**DWG ISSUED ON:
09/27/2022**

**DWG SCALE:
1/8" = 1'-0"**

**DWG NUMBER:
FPR-020**

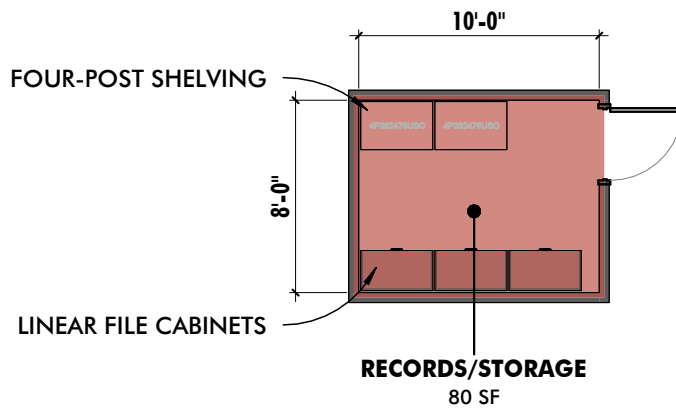

RECORDS/STORAGE

BALTIMORE CITY FIRE DEPARTMENT

COPPIN STATE PUBLIC SAFETY BUILDING



10839-D PHILADELPHIA RD
WHITE MARSH, MD 21162

410-344-1460
INFO@MWSARCH.COM
WWW.MWSARCH.COM

JOB NO:22-002

DWG ISSUED ON:
09/27/2022

DWG SCALE:
1/8" = 1'-0"

DWG NUMBER:
FPR-021

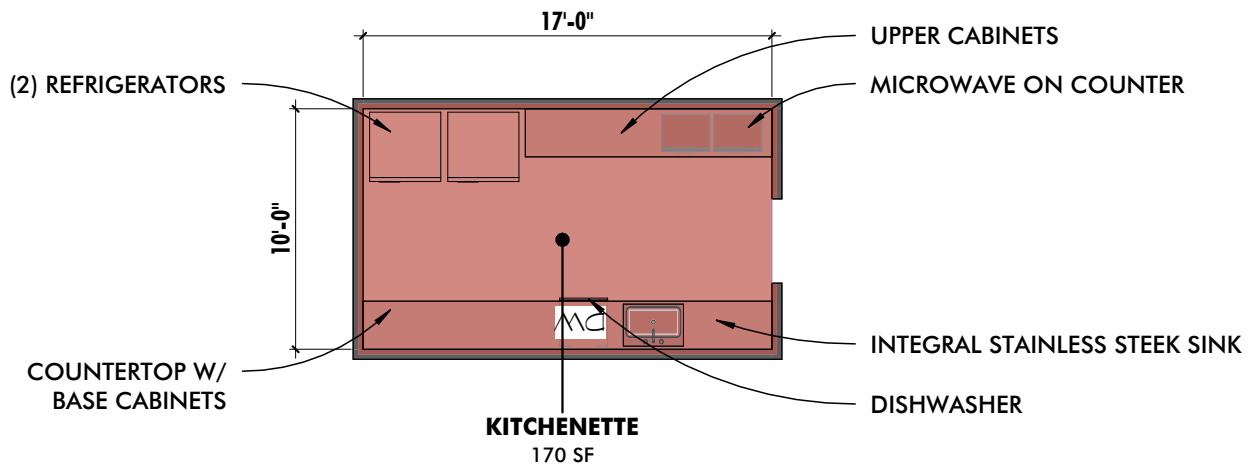

KITCHENETTE

BALTIMORE CITY FIRE DEPARTMENT

COPPIN STATE PUBLIC SAFETY BUILDING

MANN
STUDIOS
ARCHITECTURE + MASTER PLANNING

10839-D PHILADELPHIA RD
WHITE MARSH, MD 21162

410-344-1460
INFO@MWSARCH.COM
WWW.MWSARCH.COM

JOB NO:22-002

DWG ISSUED ON:
09/27/2022

DWG SCALE:
1/8" = 1'-0"

DWG NUMBER:
FPR-022

9/27/2022 7:40:09 AM

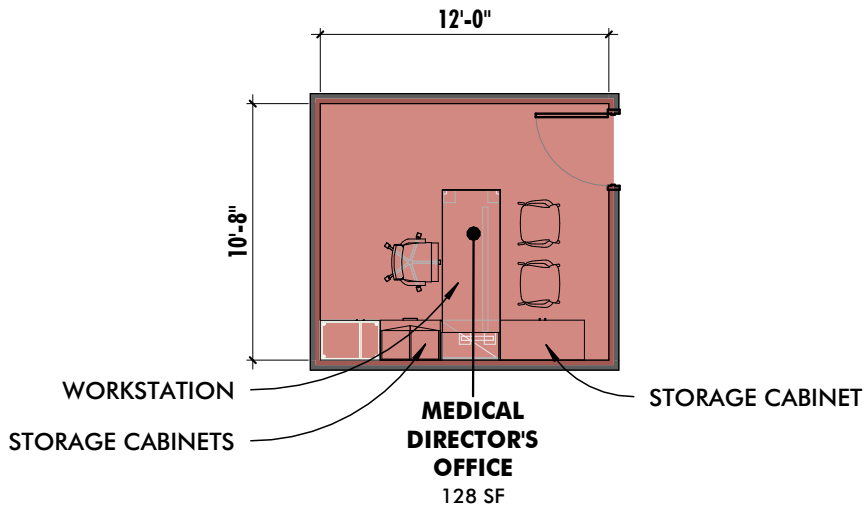

MEDICAL DIRECTOR'S OFFICE

BALTIMORE CITY FIRE DEPARTMENT

COPPIN STATE PUBLIC SAFETY BUILDING



10839-D PHILADELPHIA RD
WHITE MARSH, MD 21162

410-344-1460
INFO@MWSARCH.COM
WWW.MWSARCH.COM

JOB NO:22-002

DWG ISSUED ON:
09/27/2022

DWG SCALE:
1/8" = 1'-0"

DWG NUMBER:
FPR-023

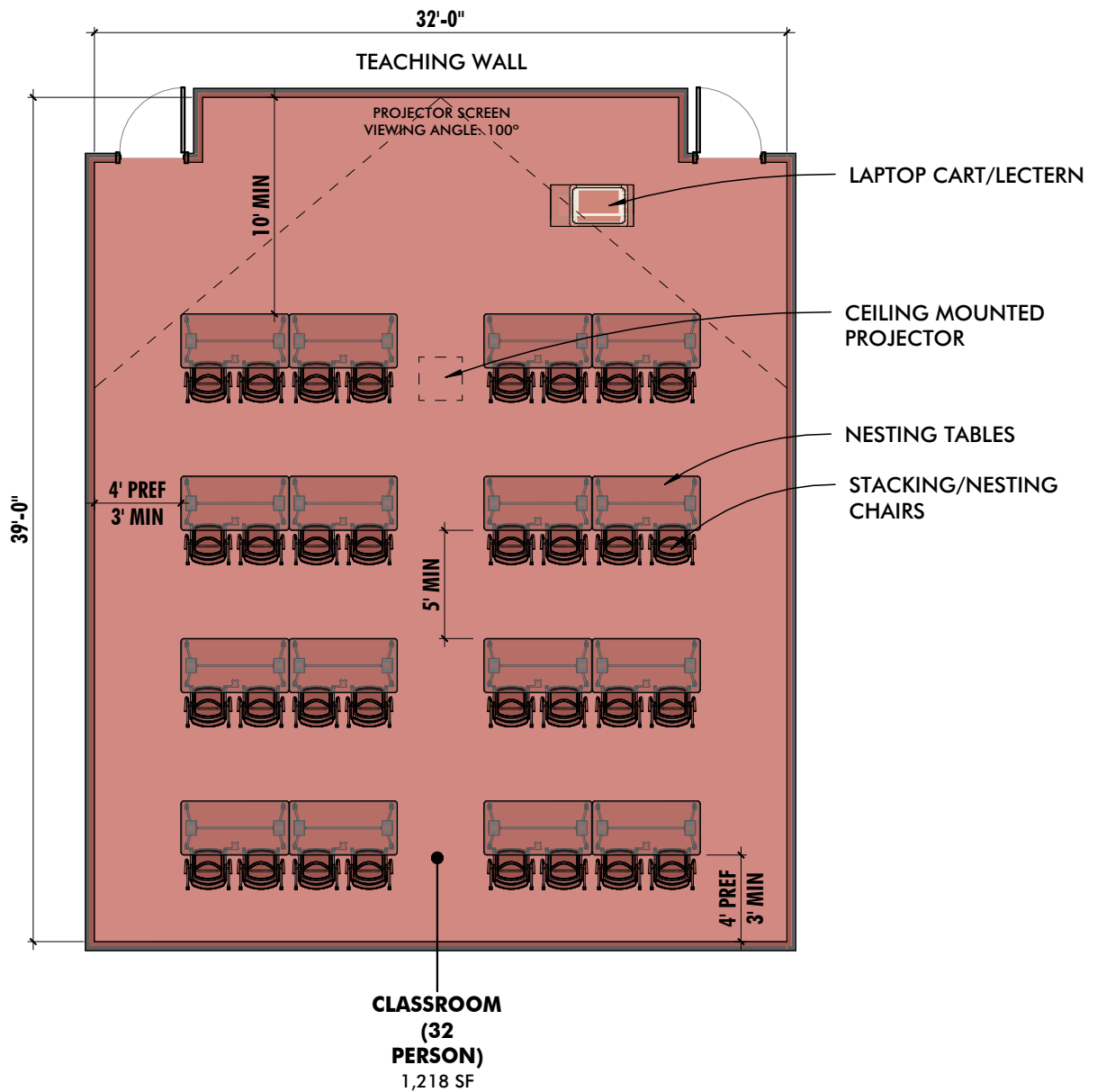

CLASSROOM (32 PERSON)
BALTIMORE CITY FIRE DEPARTMENT
COPPIN STATE PUBLIC SAFETY BUILDING



10839-D PHILADELPHIA RD
 WHITE MARSH, MD 21162
 410-344-1460
 INFO@MWSARCH.COM
 WWW.MWSARCH.COM

JOB NO:22-002
 DWG ISSUED ON:
09/27/2022
 DWG SCALE:
1/8" = 1'-0"
 DWG NUMBER:
FPR-032

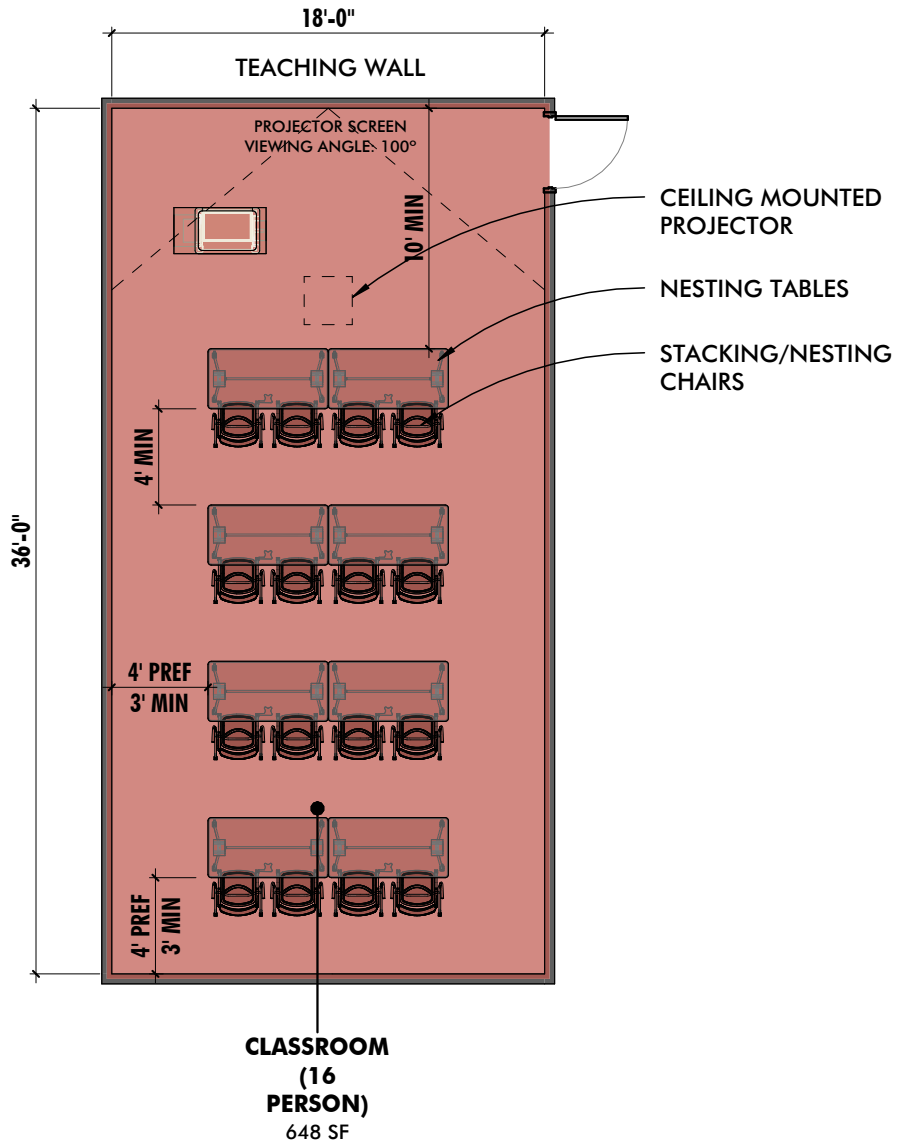

CLASSROOM (16 PERSON)
BALTIMORE CITY FIRE DEPARTMENT
COPPIN STATE PUBLIC SAFETY BUILDING



10839-D PHILADELPHIA RD
 WHITE MARSH, MD 21162
 410-344-1460
 INFO@MWSARCH.COM
 WWW.MWSARCH.COM

JOB NO:22-002
DWG ISSUED ON:
09/27/2022
DWG SCALE:
1/8" = 1'-0"
DWG NUMBER:
FPR-033

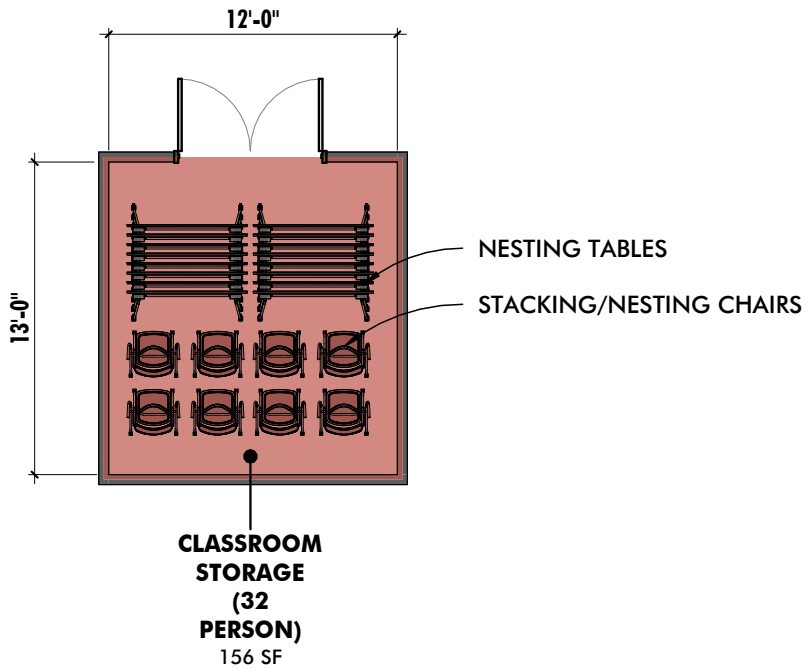

CLASSROOM STORAGE (32 PERSON)

BALTIMORE CITY FIRE DEPARTMENT

COPPIN STATE PUBLIC SAFETY BUILDING



10839-D PHILADELPHIA RD
WHITE MARSH, MD 21162

410-344-1460
INFO@MWSARCH.COM
WWW.MWSARCH.COM

JOB NO:22-002

DWG ISSUED ON:
09/27/2022

DWG SCALE:
1/8" = 1'-0"

DWG NUMBER:
FPR-034

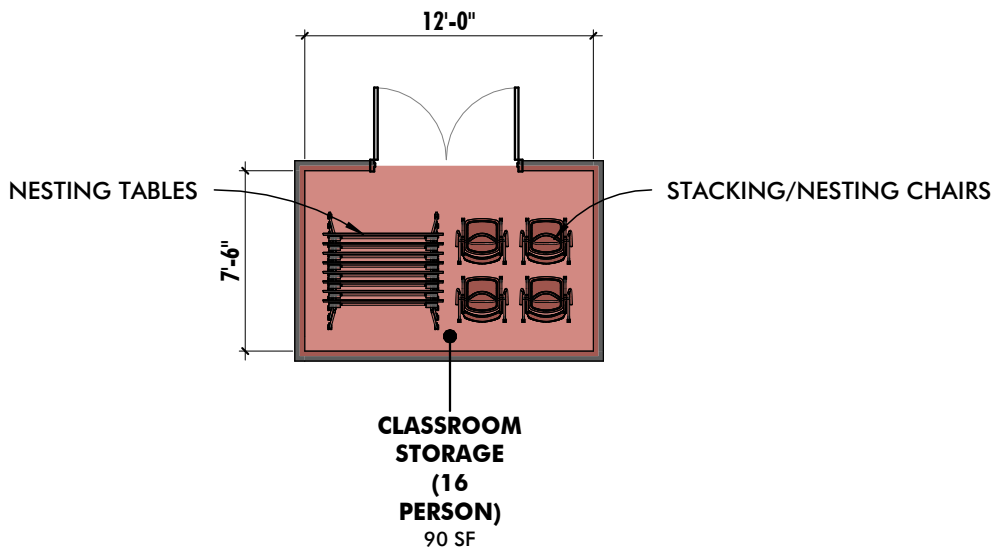

CLASSROOM STORAGE (16 PERSON)
BALTIMORE CITY FIRE DEPARTMENT
COPPIN STATE PUBLIC SAFETY BUILDING



10839-D PHILADELPHIA RD
 WHITE MARSH, MD 21162
 410-344-1460
 INFO@MWSARCH.COM
 WWW.MWSARCH.COM

JOB NO:22-002
DWG ISSUED ON:
09/27/2022
DWG SCALE:
1/8" = 1'-0"
DWG NUMBER:
FPR-035

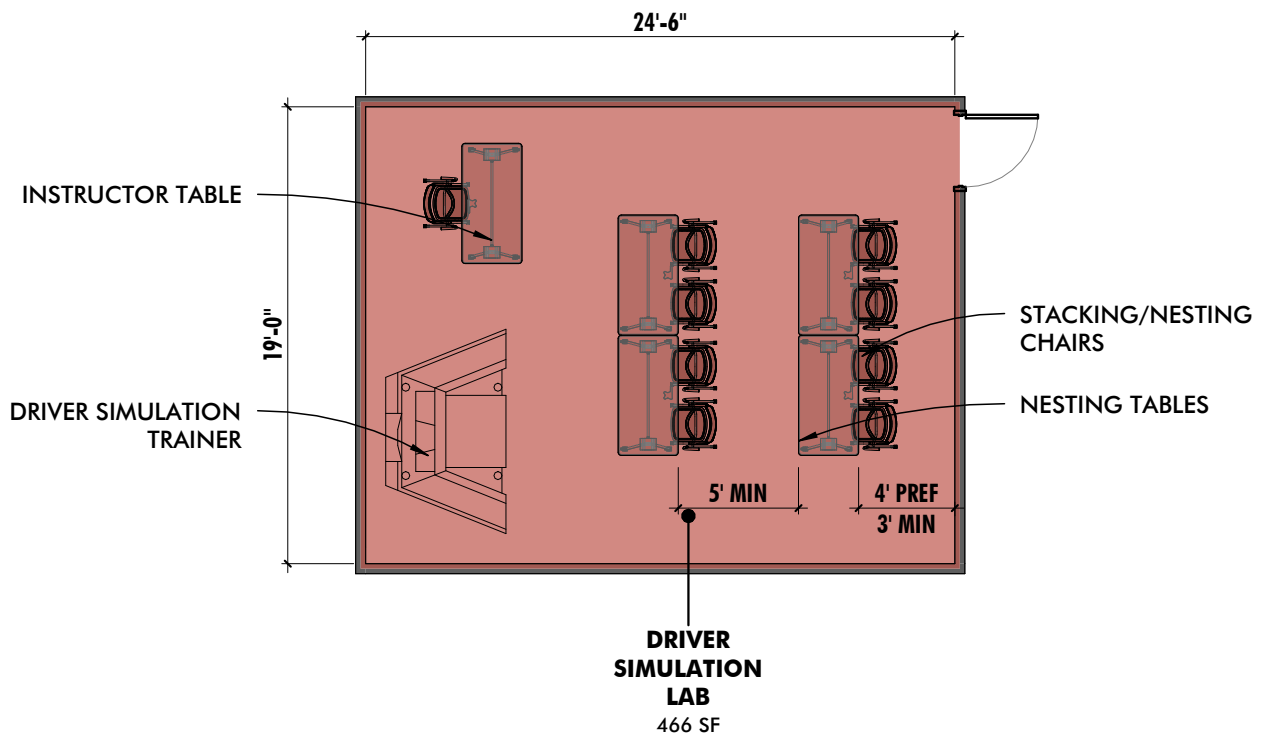

DRIVER SIMULATION LAB
BALTIMORE CITY FIRE DEPARTMENT
COPPIN STATE PUBLIC SAFETY BUILDING



10839-D PHILADELPHIA RD
 WHITE MARSH, MD 21162
 410-344-1460
 INFO@MWSARCH.COM
 WWW.MWSARCH.COM

JOB NO:22-002
DWG ISSUED ON:
09/27/2022
DWG SCALE:
1/8" = 1'-0"
DWG NUMBER:
FPR-046

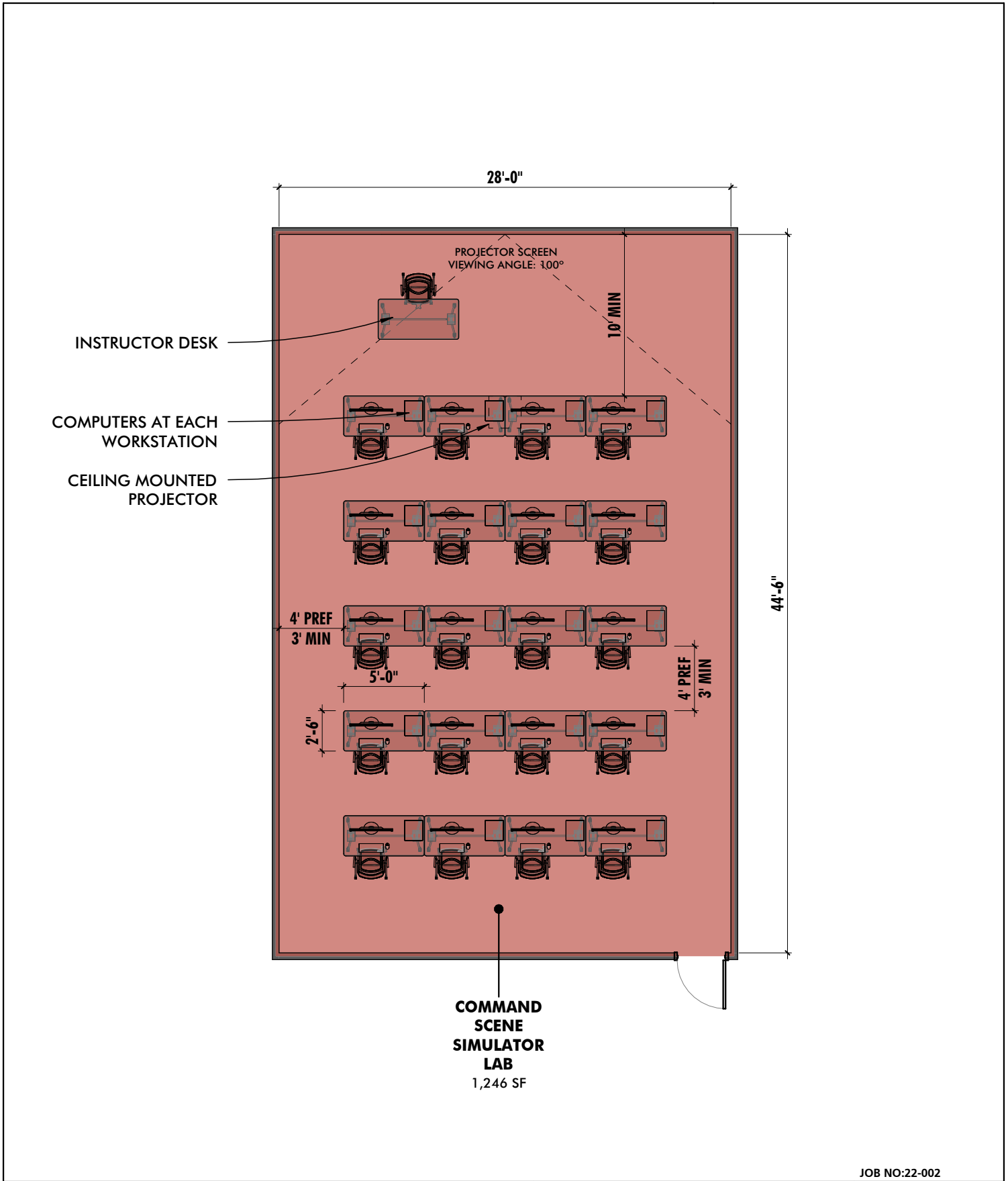

COMMAND SCENE SIMULATOR LAB

BALTIMORE CITY FIRE DEPARTMENT

COPPIN STATE PUBLIC SAFETY BUILDING



10839-D PHILADELPHIA RD
WHITE MARSH, MD 21162

410-344-1460
INFO@MWSARCH.COM
WWW.MWSARCH.COM

ARCHITECTURE + MASTER PLANNING

JOB NO:22-002
DWG ISSUED ON: 09/27/2022
DWG SCALE: 1/8" = 1'-0"
DWG NUMBER: FPR-047

9/27/2022 7:43:26 AM

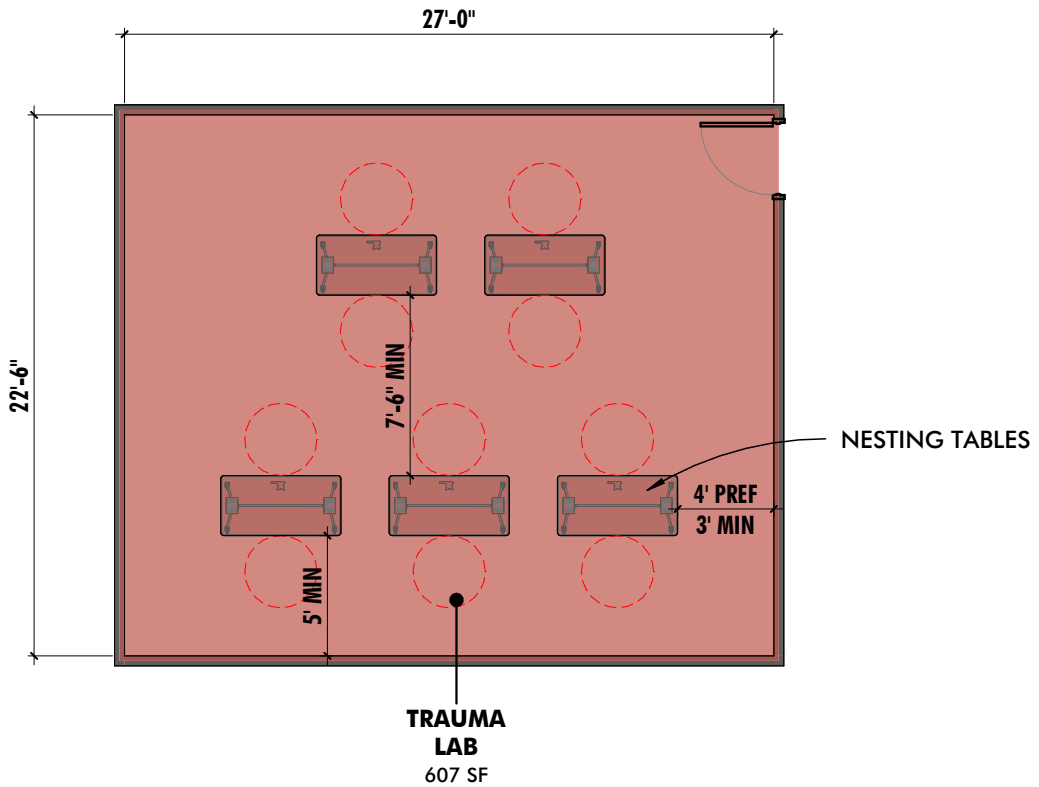

TRAUMA LAB
BALTIMORE CITY FIRE DEPARTMENT
COPPIN STATE PUBLIC SAFETY BUILDING



10839-D PHILADELPHIA RD
 WHITE MARSH, MD 21162
 410-344-1460
 INFO@MWSARCH.COM
 WWW.MWSARCH.COM

JOB NO:22-002
DWG ISSUED ON:
09/27/2022
DWG SCALE:
1/8" = 1'-0"
DWG NUMBER:
FPR-053

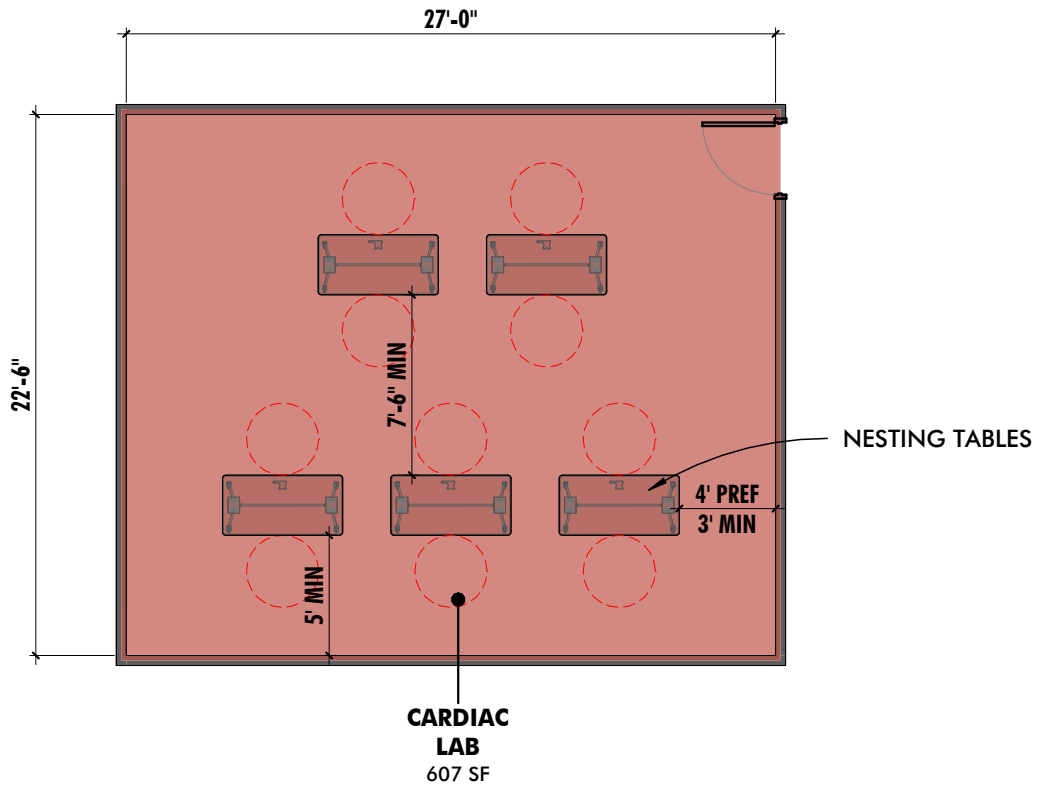

CARDIAC LAB
BALTIMORE CITY FIRE DEPARTMENT
COPPIN STATE PUBLIC SAFETY BUILDING



10839-D PHILADELPHIA RD
 WHITE MARSH, MD 21162
 410-344-1460
 INFO@MWSARCH.COM
 WWW.MWSARCH.COM

JOB NO:22-002
DWG ISSUED ON:
09/27/2022
DWG SCALE:
1/8" = 1'-0"
DWG NUMBER:
FPR-054

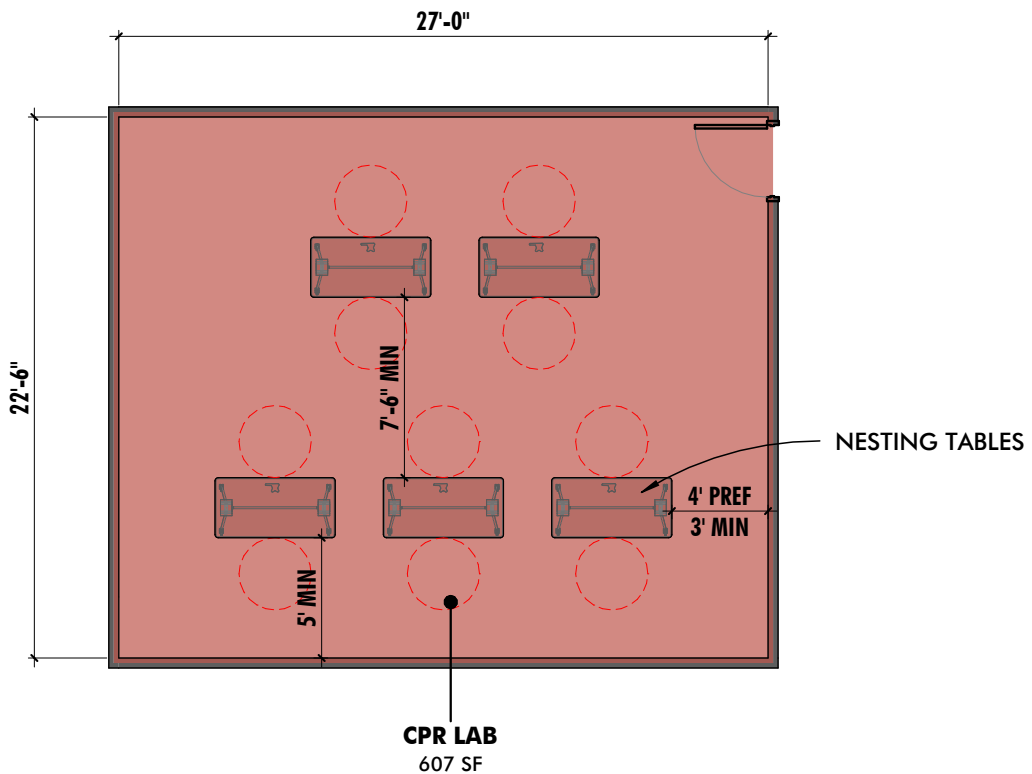

CPR LAB

BALTIMORE CITY FIRE DEPARTMENT

COPPIN STATE PUBLIC SAFETY BUILDING



10839-D PHILADELPHIA RD
WHITE MARSH, MD 21162

410-344-1460
INFO@MWSARCH.COM
WWW.MWSARCH.COM

JOB NO:22-002

DWG ISSUED ON:
09/27/2022

DWG SCALE:
1/8" = 1'-0"

DWG NUMBER:
FPR-055

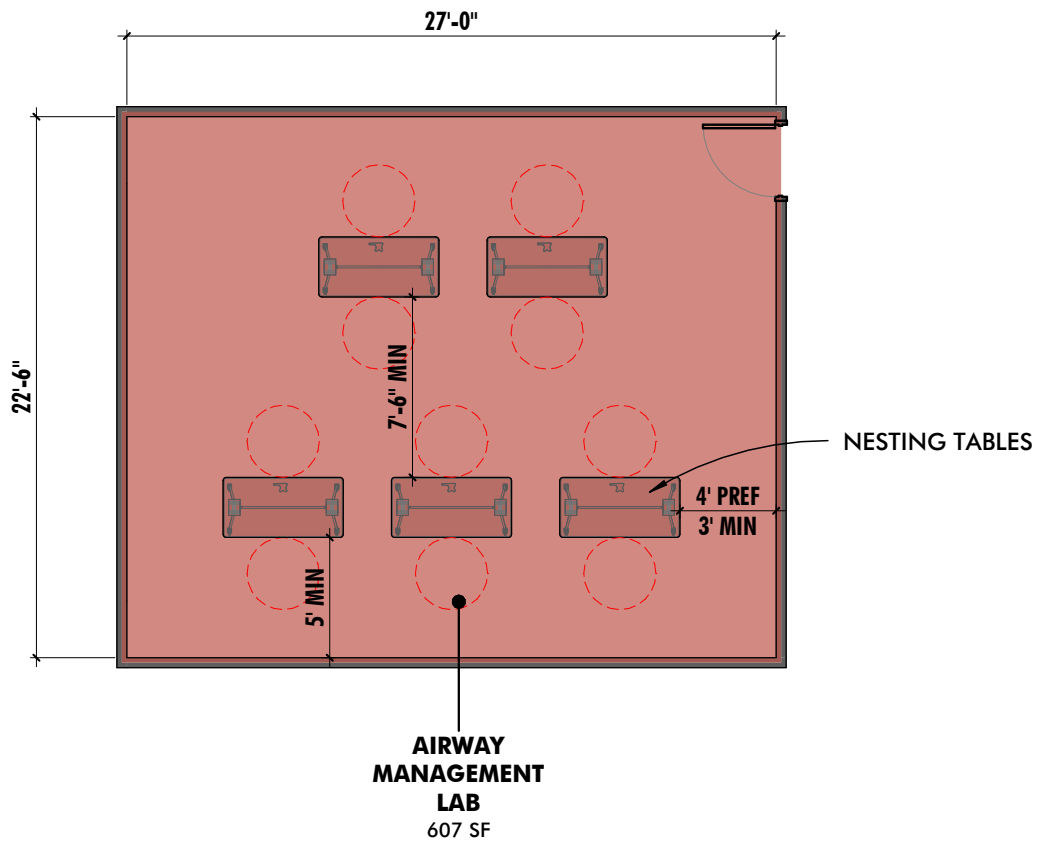

AIRWAY MANAGEMENT LAB
BALTIMORE CITY FIRE DEPARTMENT
COPPIN STATE PUBLIC SAFETY BUILDING



10839-D PHILADELPHIA RD
 WHITE MARSH, MD 21162
 410-344-1460
 INFO@MWSARCH.COM
 WWW.MWSARCH.COM

JOB NO:22-002
DWG ISSUED ON:
09/27/2022
DWG SCALE:
1/8" = 1'-0"
DWG NUMBER:
FPR-056

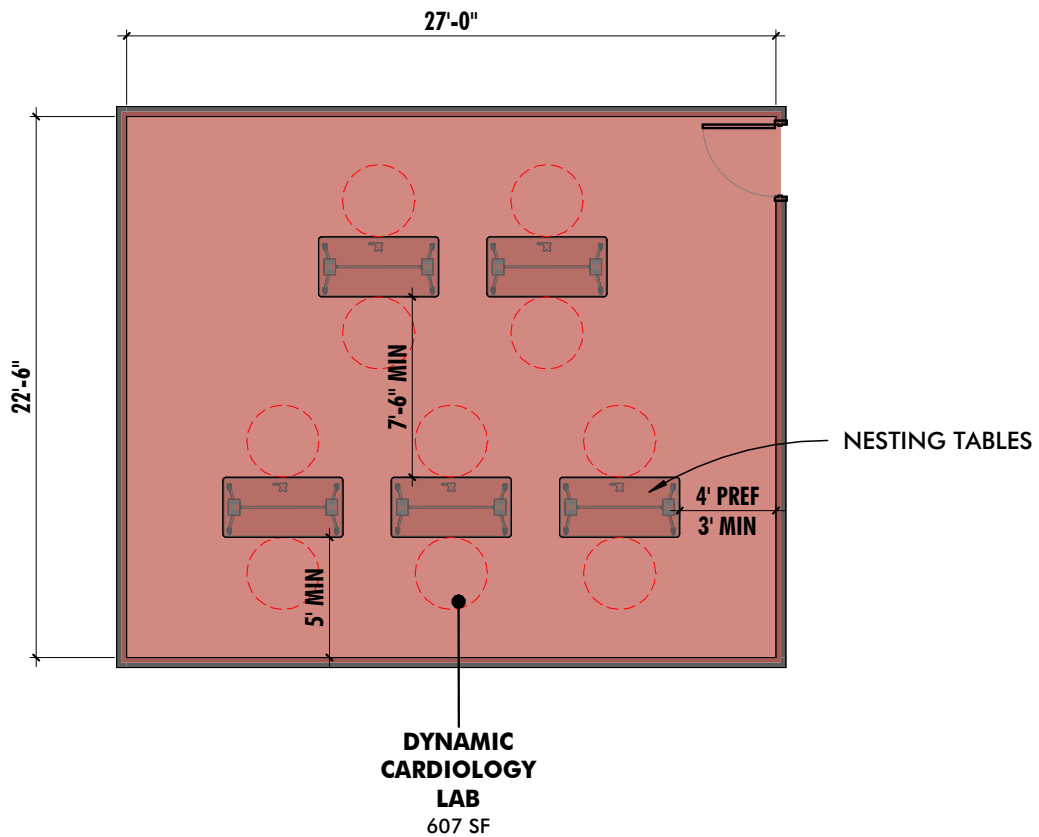

DYANMIC CARDIOLOGY LAB
BALTIMORE CITY FIRE DEPARTMENT
COPPIN STATE PUBLIC SAFETY BUILDING



10839-D PHILADELPHIA RD
 WHITE MARSH, MD 21162
 410-344-1460
 INFO@MWSARCH.COM
 WWW.MWSARCH.COM

JOB NO:22-002
DWG ISSUED ON:
09/27/2022
DWG SCALE:
1/8" = 1'-0"
DWG NUMBER:
FPR-057

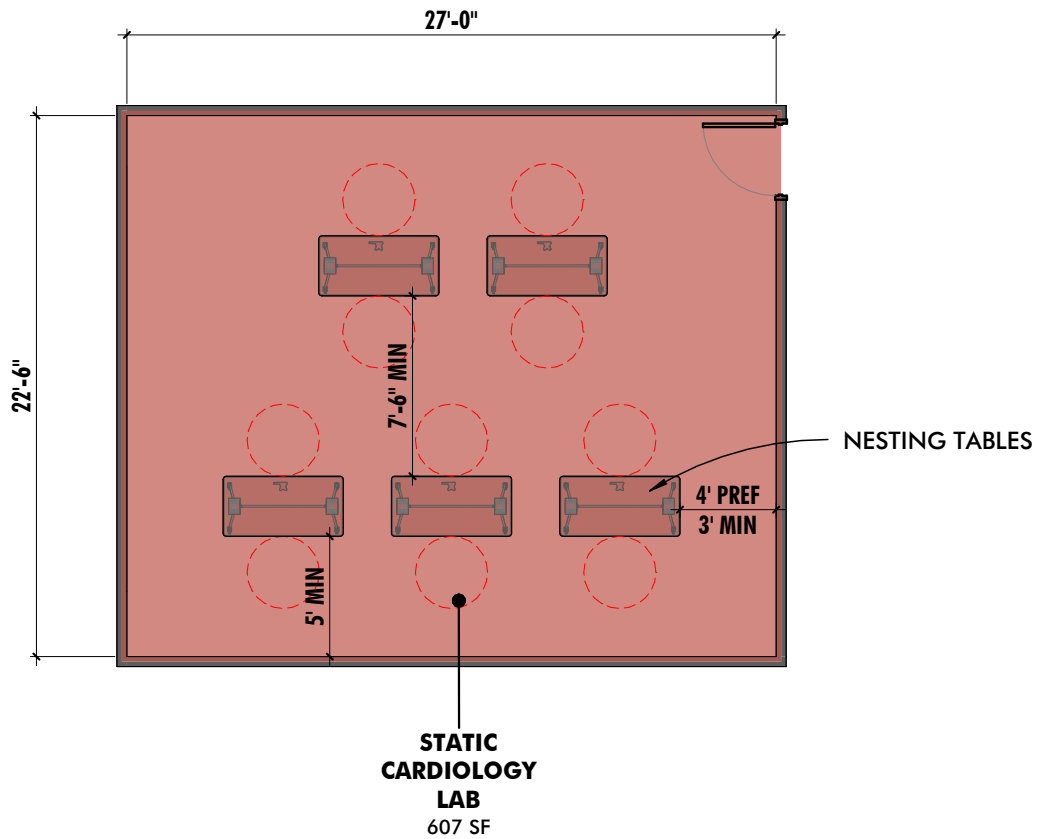

STATIC CARDIOLOGY LAB
BALTIMORE CITY FIRE DEPARTMENT
COPPIN STATE PUBLIC SAFETY BUILDING



10839-D PHILADELPHIA RD
 WHITE MARSH, MD 21162
 410-344-1460
 INFO@MWSARCH.COM
 WWW.MWSARCH.COM

JOB NO:22-002
 DWG ISSUED ON:
09/27/2022
 DWG SCALE:
1/8" = 1'-0"
 DWG NUMBER:
FPR-058

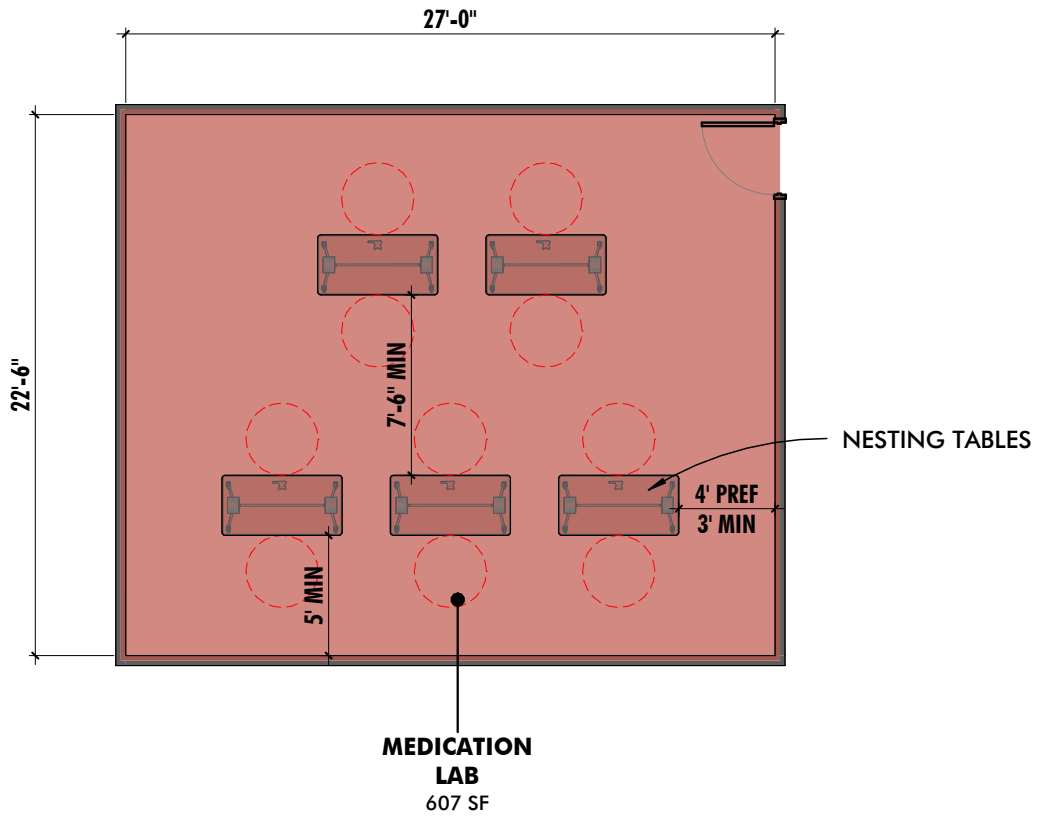

MEDICATION LAB

BALTIMORE CITY FIRE DEPARTMENT

COPPIN STATE PUBLIC SAFETY BUILDING



10839-D PHILADELPHIA RD
WHITE MARSH, MD 21162

410-344-1460
INFO@MWSARCH.COM
WWW.MWSARCH.COM

JOB NO:22-002

DWG ISSUED ON:
09/27/2022

DWG SCALE:
1/8" = 1'-0"

DWG NUMBER:
FPR-059

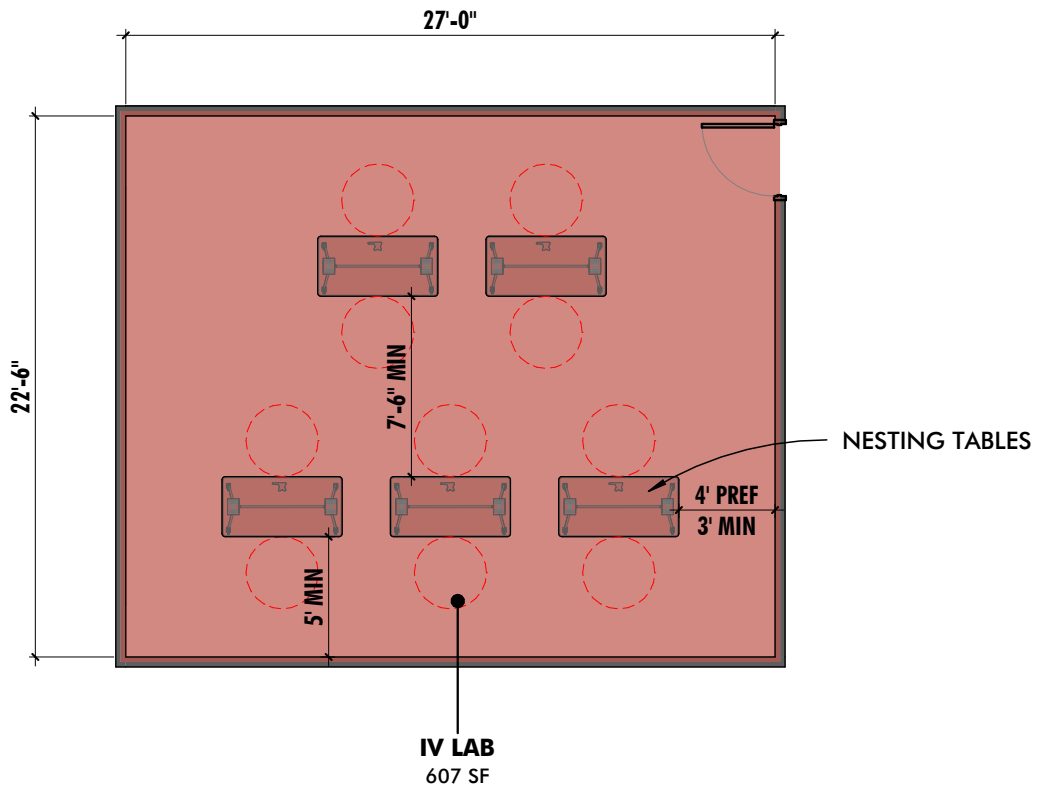

IV LAB
BALTIMORE CITY FIRE DEPARTMENT
COPPIN STATE PUBLIC SAFETY BUILDING



10839-D PHILADELPHIA RD
 WHITE MARSH, MD 21162
 410-344-1460
 INFO@MWSARCH.COM
 WWW.MWSARCH.COM

JOB NO:22-002
DWG ISSUED ON:
09/27/2022
DWG SCALE:
1/8" = 1'-0"
DWG NUMBER:
FPR-060

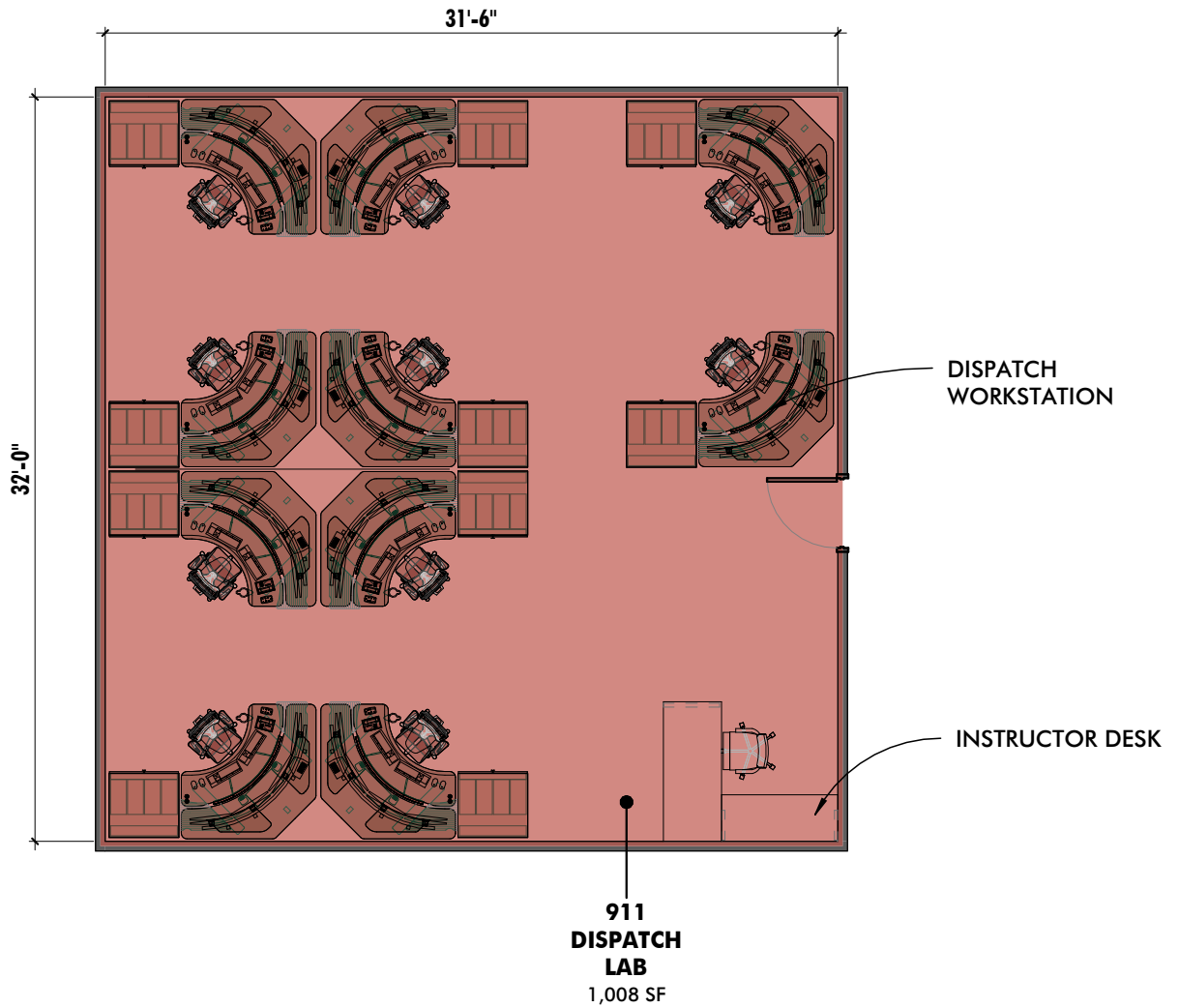

911 DISPATCH LAB
BALTIMORE CITY FIRE DEPARTMENT
COPPIN STATE PUBLIC SAFETY BUILDING



10839-D PHILADELPHIA RD
 WHITE MARSH, MD 21162
 410-344-1460
 INFO@MWSARCH.COM
 WWW.MWSARCH.COM

JOB NO:22-002
 DWG ISSUED ON:
09/27/2022
 DWG SCALE:
1/8" = 1'-0"
 DWG NUMBER:
FPR-061

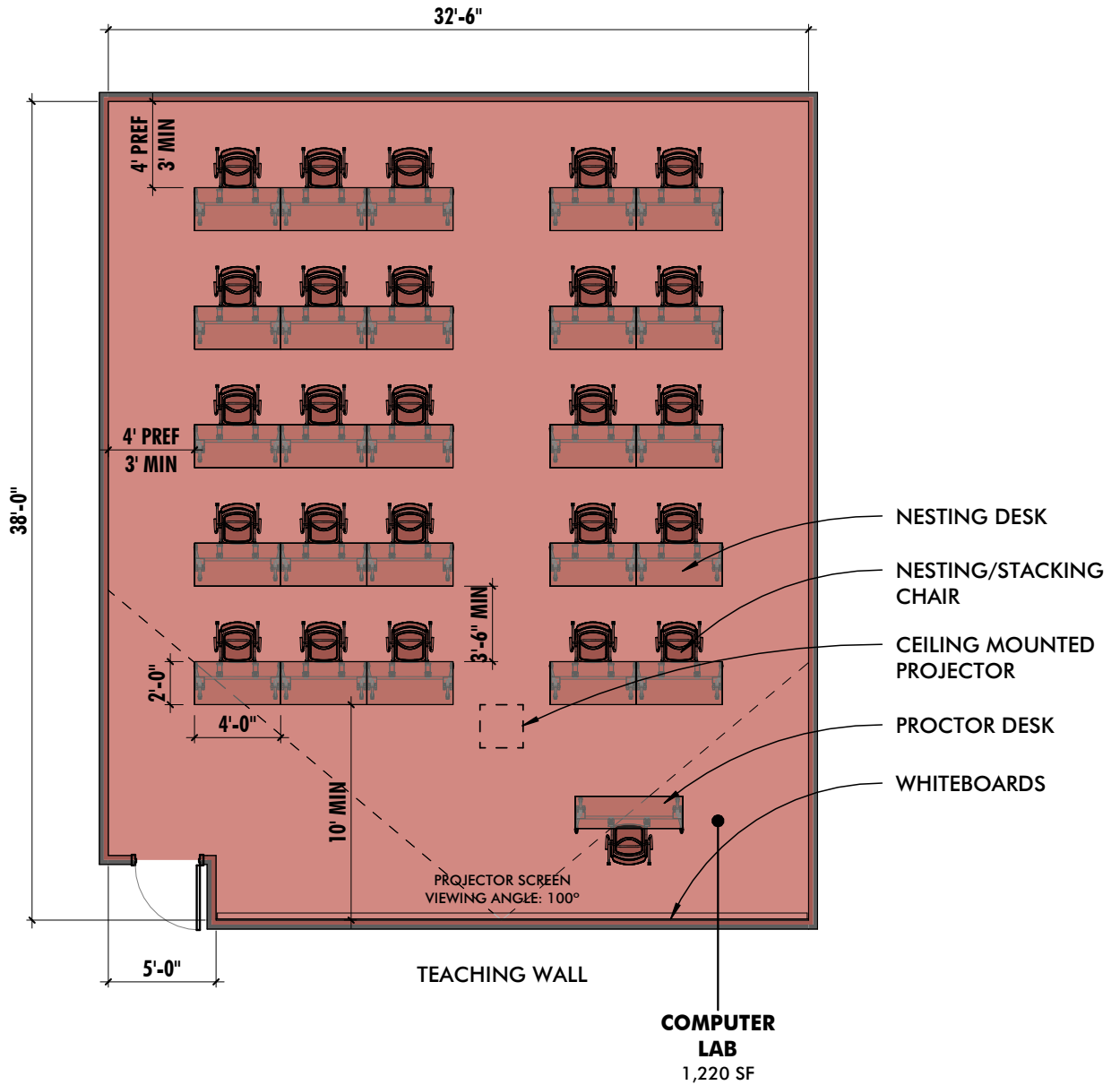

ALS CONTINUING EDUCATION COMPUTER LAB
BALTIMORE CITY FIRE DEPARTMENT
COPPIN STATE PUBLIC SAFETY BUILDING



10839-D PHILADELPHIA RD
 WHITE MARSH, MD 21162
 410-344-1460
 INFO@MWSARCH.COM
 WWW.MWSARCH.COM

JOB NO:22-002
 DWG ISSUED ON:
09/27/2022
 DWG SCALE:
1/8" = 1'-0"
 DWG NUMBER:
FPR-062

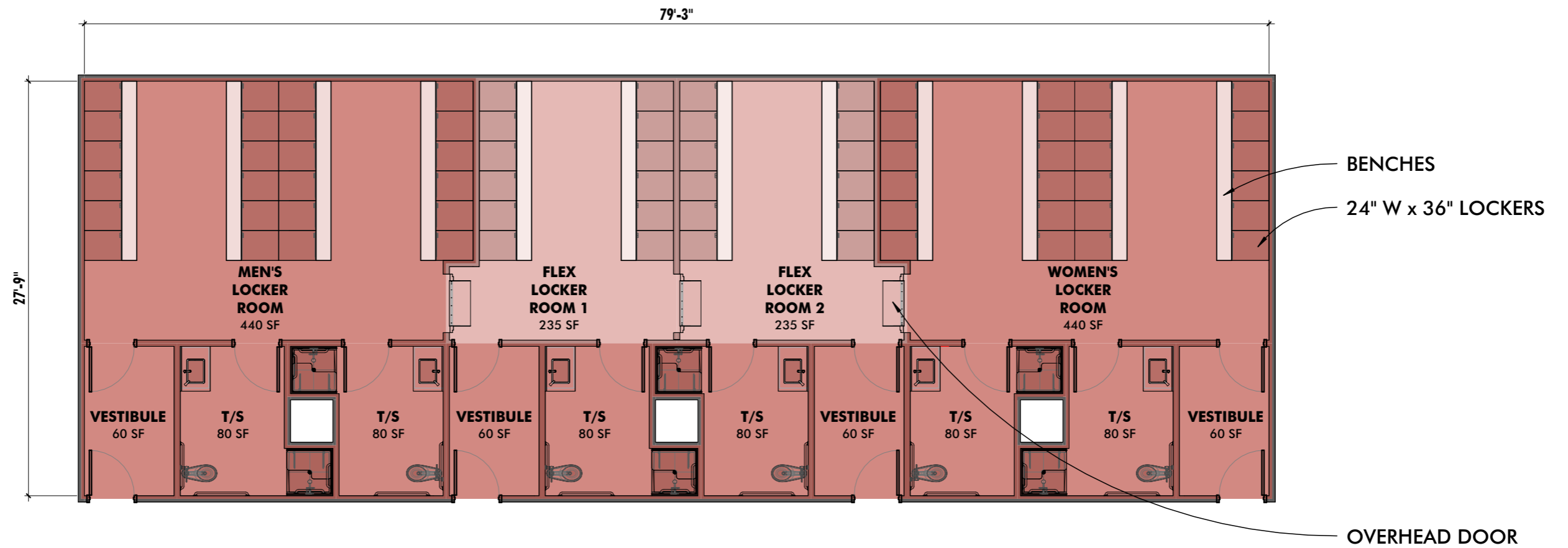

ACADEMY STUDENT LOCKERS
BALTIMORE CITY FIRE DEPARTMENT
COPPIN STATE PUBLIC SAFETY BUILDING



10839-D PHILADELPHIA RD
 WHITE MARSH, MD 21162
 410-344-1460
 INFO@MWSARCH.COM
 WWW.MWSARCH.COM

JOB NO:22-002
 DWG ISSUED ON:
09/27/2022
 DWG SCALE:
 1/8" = 1'-0"
 DWG NUMBER:
FPR-072

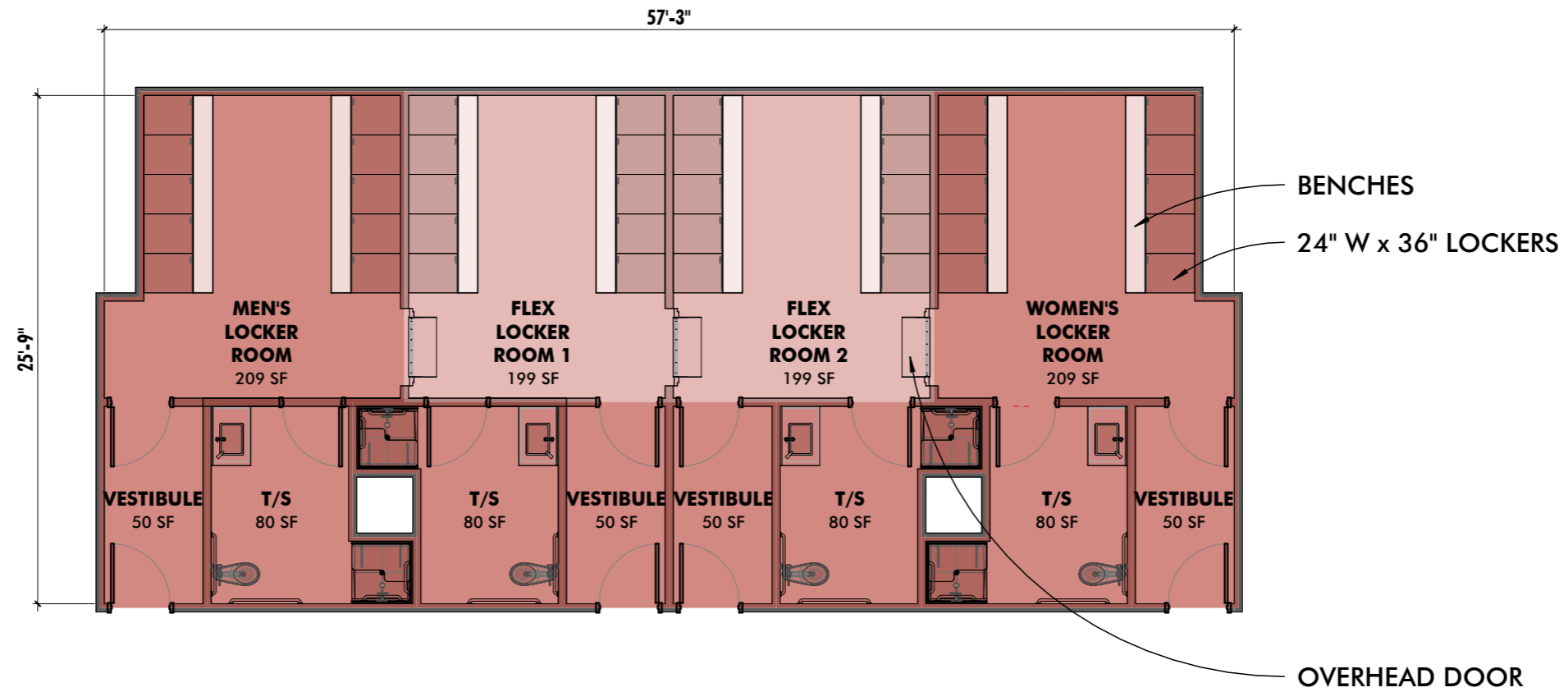

INSTRUCTOR LOCKERS
BALTIMORE CITY FIRE DEPARTMENT
COPPIN STATE PUBLIC SAFETY BUILDING



10839-D PHILADELPHIA RD
 WHITE MARSH, MD 21162
 410-344-1460
 INFO@MWSARCH.COM
 WWW.MWSARCH.COM

JOB NO:22-002

DWG ISSUED ON:
09/27/2022

DWG SCALE:
 1/8" = 1'-0"

DWG NUMBER:
FPR-073

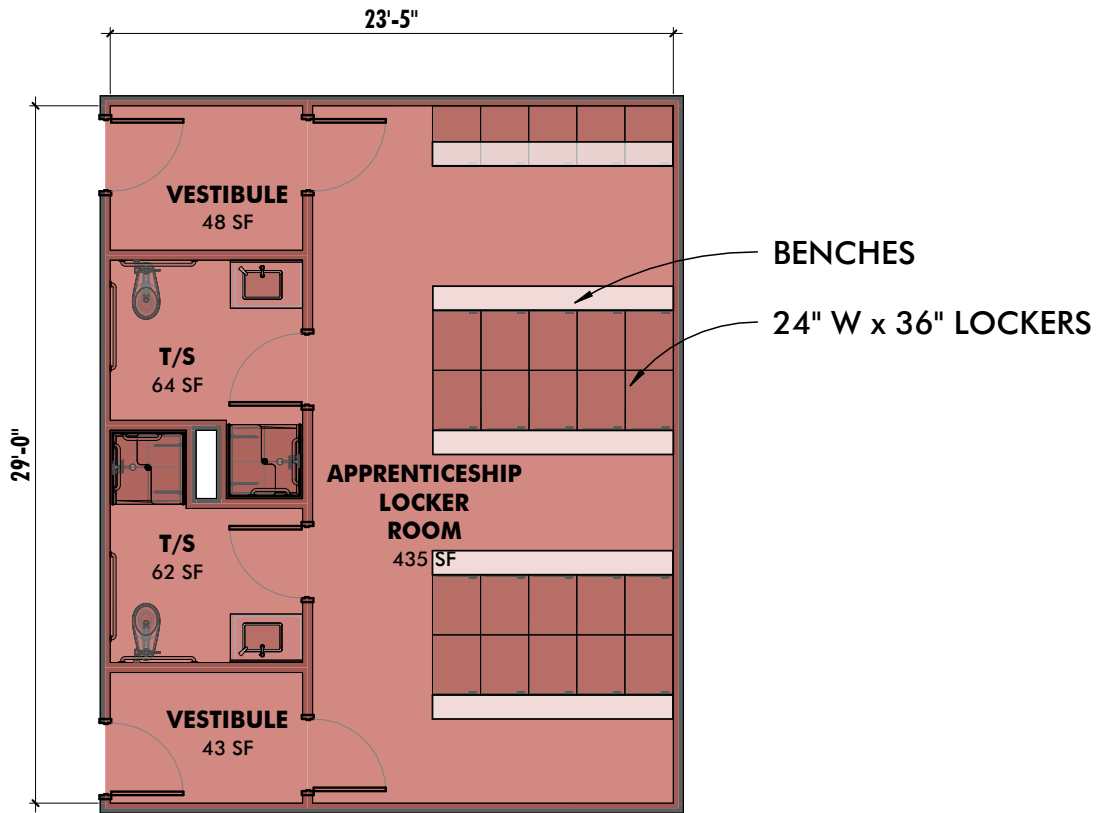

APPRENTICESHIP LOCKER ROOM
BALTIMORE CITY FIRE DEPARTMENT
COPPIN STATE PUBLIC SAFETY BUILDING



10839-D PHILADELPHIA RD
 WHITE MARSH, MD 21162
 410-344-1460
 INFO@MWSARCH.COM
 WWW.MWSARCH.COM

JOB NO:22-002
 DWG ISSUED ON:
09/27/2022
 DWG SCALE:
1/8" = 1'-0"
 DWG NUMBER:
FPR-074

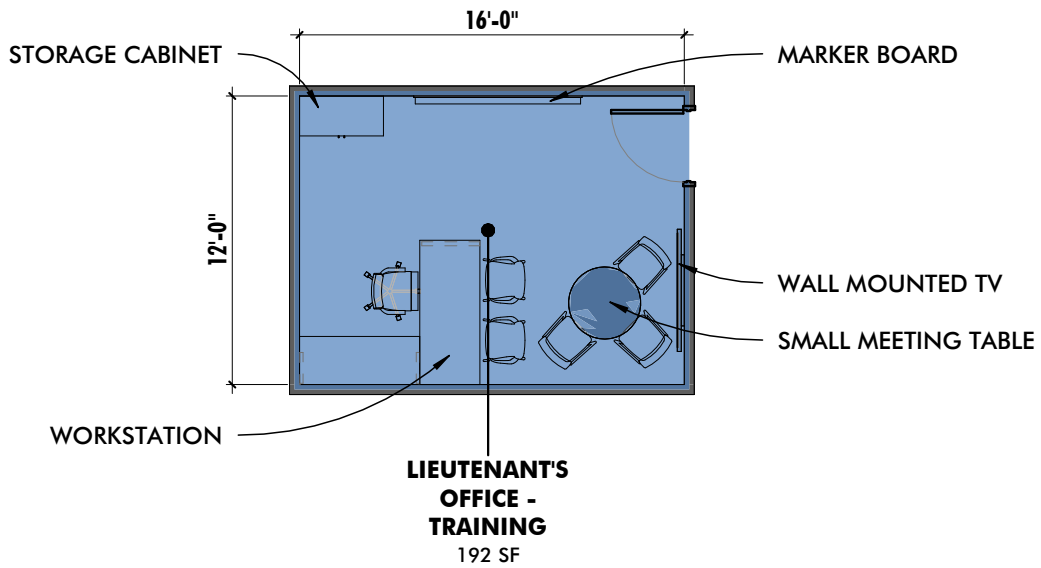

LIEUTENANT'S OFFICE - TRAINING
BALTIMORE POLICE DEPARTMENT
COPPIN STATE PUBLIC SAFETY BUILDING



10839-D PHILADELPHIA RD
 WHITE MARSH, MD 21162
 410-344-1460
 INFO@MWSARCH.COM
 WWW.MWSARCH.COM

JOB NO:22-002
DWG ISSUED ON:
09/27/2022
DWG SCALE:
1/8" = 1'-0"
DWG NUMBER:
PPR-001

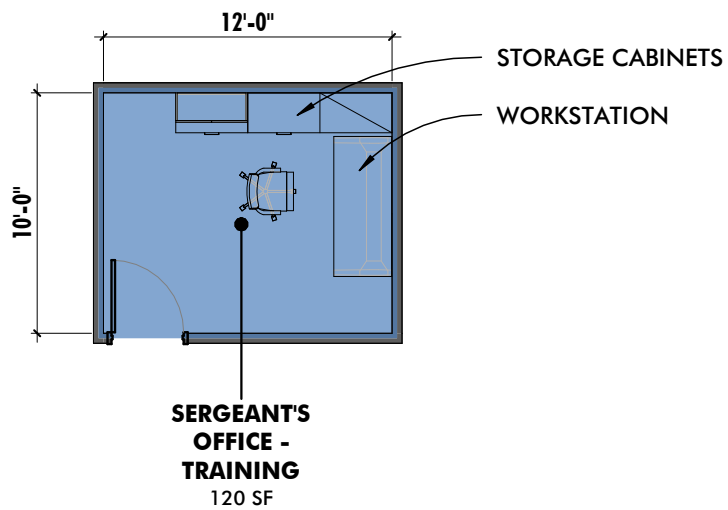

SERGEANT'S OFFICE - TRAINING

BALTIMORE POLICE DEPARTMENT

COPPIN STATE PUBLIC SAFETY BUILDING



10839-D PHILADELPHIA RD
WHITE MARSH, MD 21162

410-344-1460
INFO@MWSARCH.COM
WWW.MWSARCH.COM

JOB NO:22-002

DWG ISSUED ON:
09/27/2022

DWG SCALE:
1/8" = 1'-0"

DWG NUMBER:
PPR-002

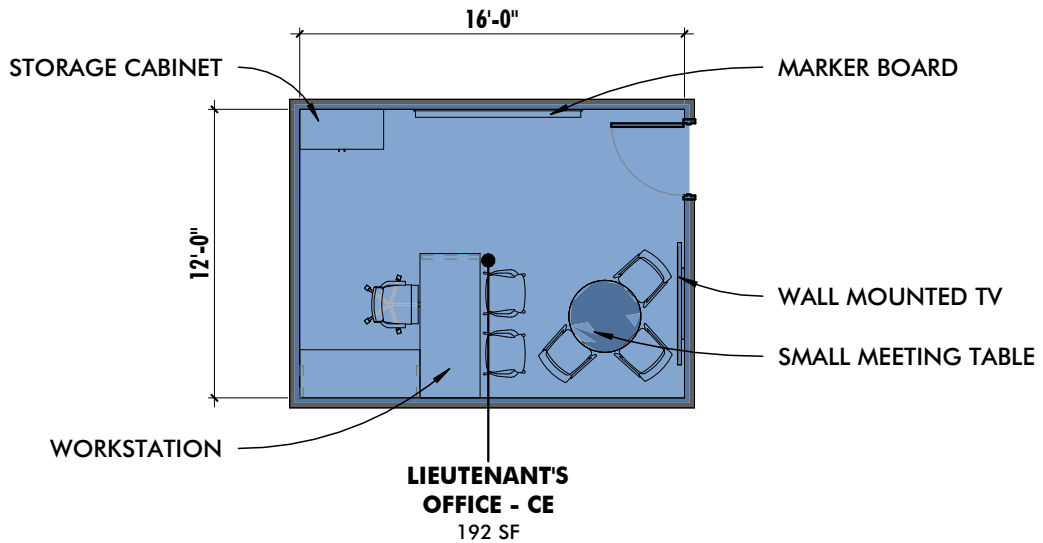

LIEUTENANT'S OFFICE - CE

BALTIMORE POLICE DEPARTMENT

COPPIN STATE PUBLIC SAFETY BUILDING



10839-D PHILADELPHIA RD
WHITE MARSH, MD 21162

410-344-1460
INFO@MWSARCH.COM
WWW.MWSARCH.COM

JOB NO:22-002

DWG ISSUED ON:
09/27/2022

DWG SCALE:
1/8" = 1'-0"

DWG NUMBER:
PPR-014

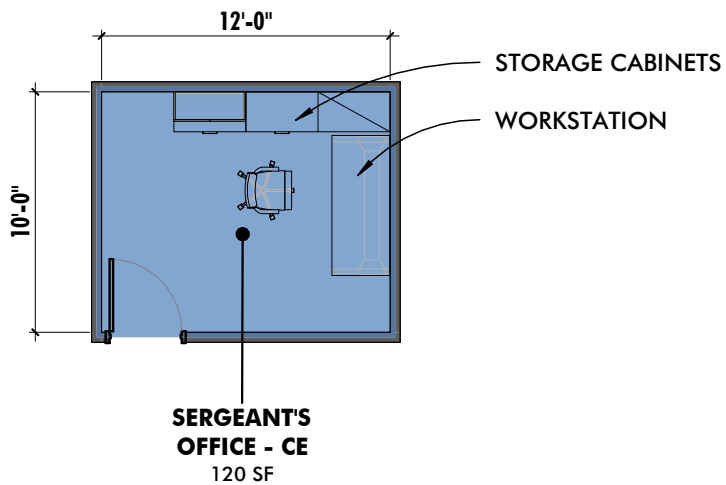

SERGEANT'S OFFICE - CE

BALTIMORE POLICE DEPARTMENT

COPPIN STATE PUBLIC SAFETY BUILDING



10839-D PHILADELPHIA RD
WHITE MARSH, MD 21162

410-344-1460
INFO@MWSARCH.COM
WWW.MWSARCH.COM

JOB NO:22-002

DWG ISSUED ON:
09/27/2022

DWG SCALE:
1/8" = 1'-0"

DWG NUMBER:
PPR-015

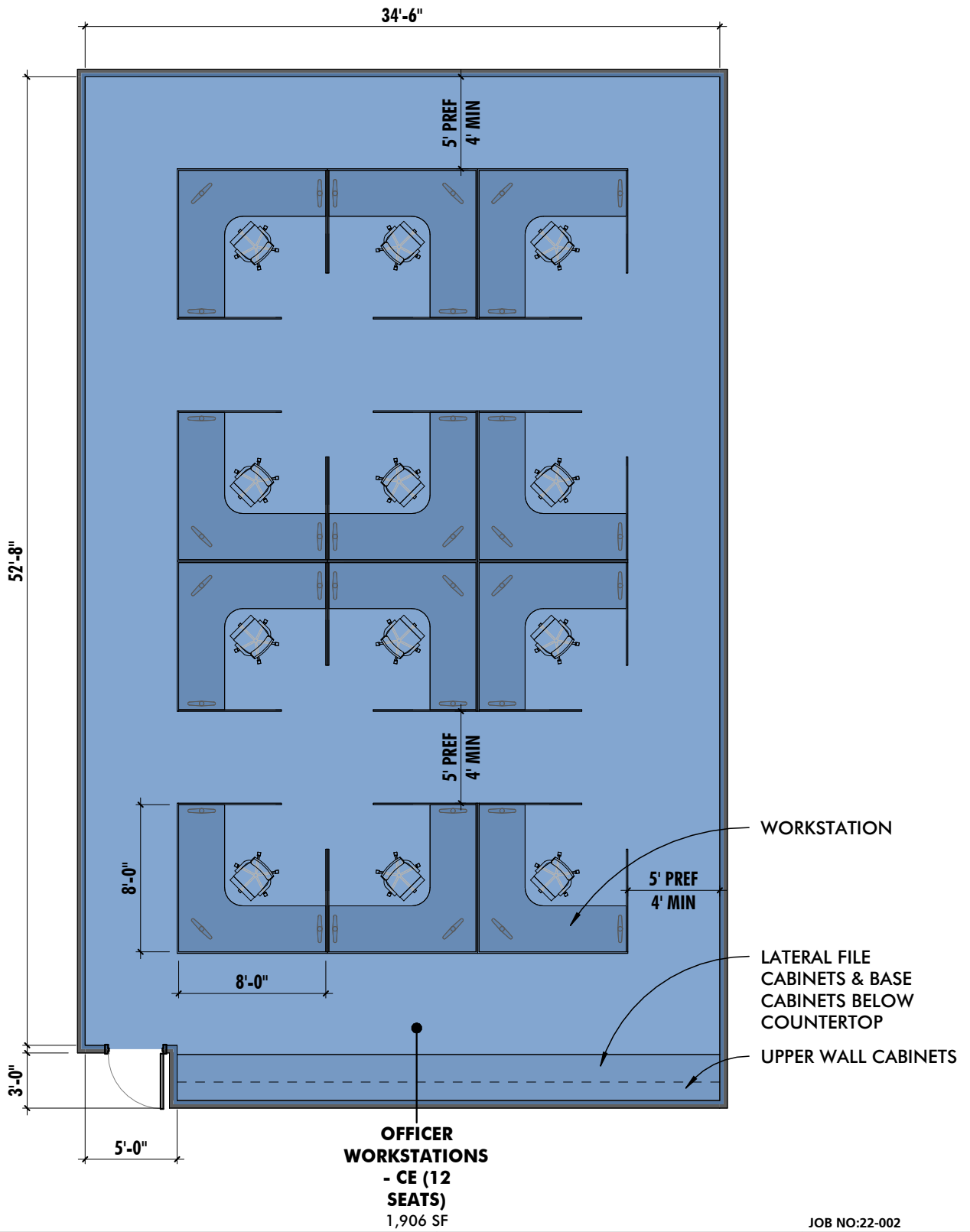

OFFICER WORKSTATIONS - CE
BALTIMORE POLICE DEPARTMENT
COPPIN STATE PUBLIC SAFETY BUILDING



10839-D PHILADELPHIA RD
 WHITE MARSH, MD 21162
 410-344-1460
 INFO@MWSARCH.COM
 WWW.MWSARCH.COM

JOB NO:22-002
DWG ISSUED ON:
09/27/2022
DWG SCALE:
1/8" = 1'-0"
DWG NUMBER:
PPR-016

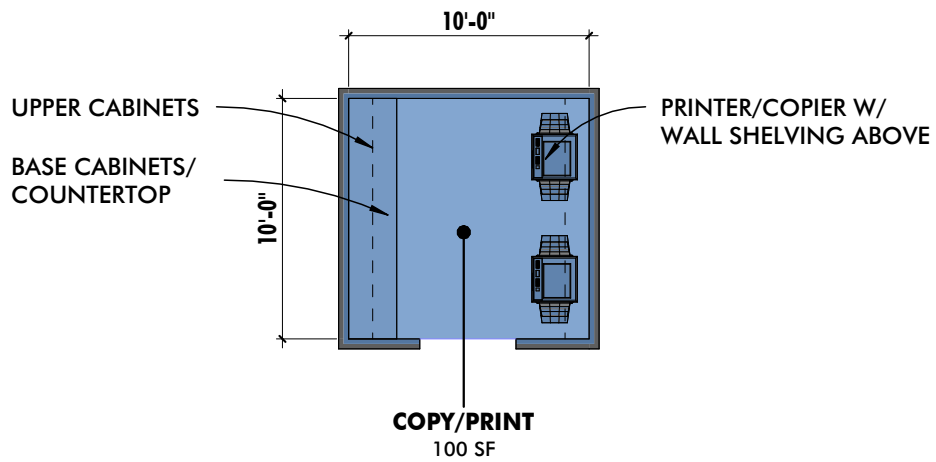

COPY/PRINT
BALTIMORE POLICE DEPARTMENT
COPPIN STATE PUBLIC SAFETY BUILDING



10839-D PHILADELPHIA RD
 WHITE MARSH, MD 21162
 410-344-1460
 INFO@MWSARCH.COM
 WWW.MWSARCH.COM

JOB NO:22-002
DWG ISSUED ON:
09/27/2022
DWG SCALE:
1/8" = 1'-0"
DWG NUMBER:
PPR-017

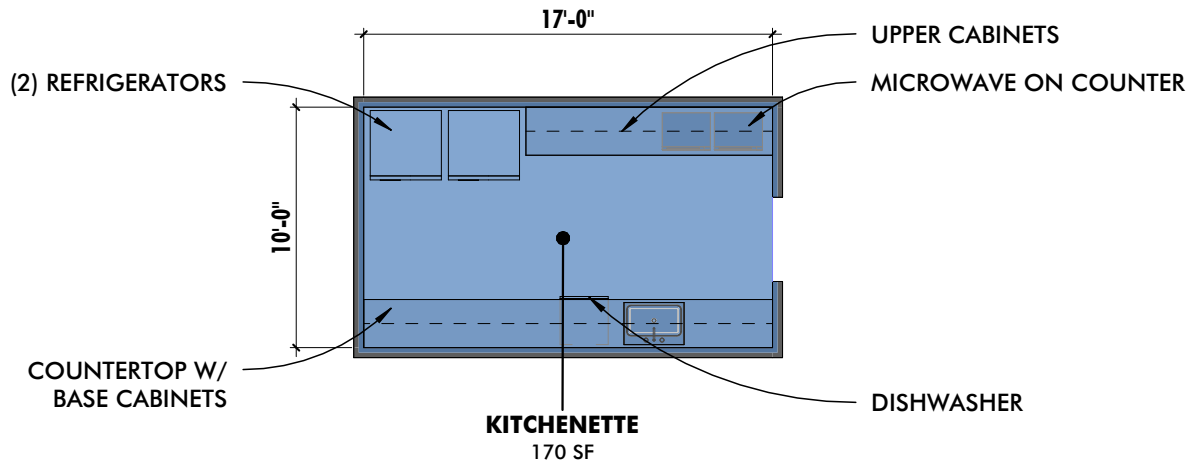

KITCHENETTE

BALTIMORE POLICE DEPARTMENT

COPPIN STATE PUBLIC SAFETY BUILDING



10839-D PHILADELPHIA RD
WHITE MARSH, MD 21162

410-344-1460
INFO@MWSARCH.COM
WWW.MWSARCH.COM

JOB NO:22-002

DWG ISSUED ON:
09/27/2022

DWG SCALE:
1/8" = 1'-0"

DWG NUMBER:
PPR-018

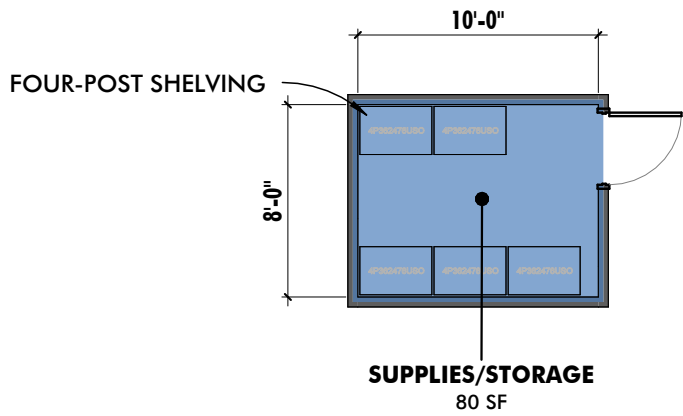

STORAGE - OFFICE SUPPLIES

BALTIMORE POLICE DEPARTMENT

COPPIN STATE PUBLIC SAFETY BUILDING



10839-D PHILADELPHIA RD
WHITE MARSH, MD 21162

410-344-1460
INFO@MWSARCH.COM
WWW.MWSARCH.COM

JOB NO:22-002

DWG ISSUED ON:
09/27/2022

DWG SCALE:
1/8" = 1'-0"

DWG NUMBER:
PPR-019

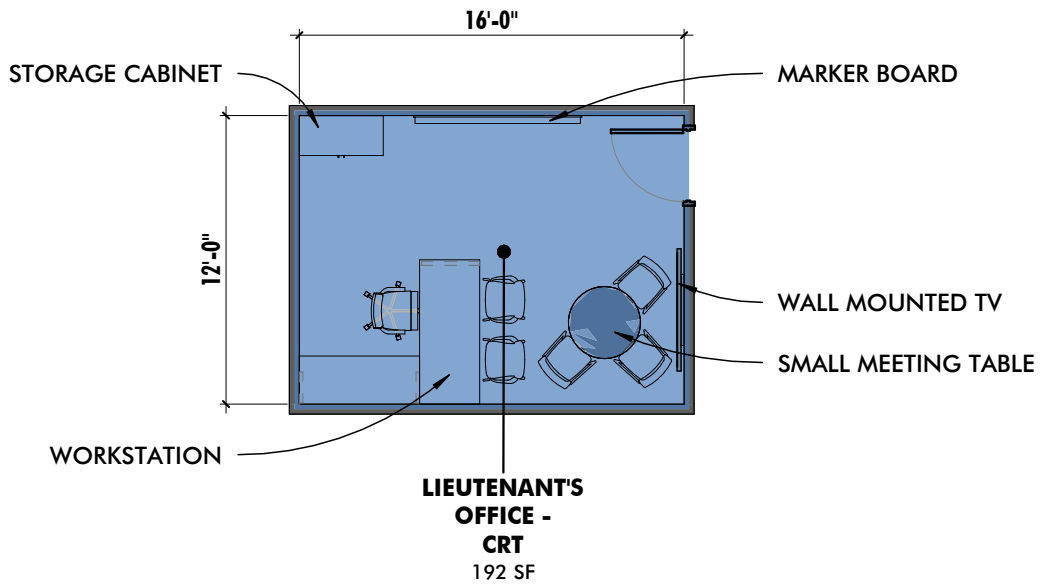

LIEUTENANT'S OFFICE - CRT
BALTIMORE POLICE DEPARTMENT
COPPIN STATE PUBLIC SAFETY BUILDING



10839-D PHILADELPHIA RD
 WHITE MARSH, MD 21162
 410-344-1460
 INFO@MWSARCH.COM
 WWW.MWSARCH.COM

JOB NO:22-002
DWG ISSUED ON:
09/27/2022
DWG SCALE:
1/8" = 1'-0"
DWG NUMBER:
PPR-027

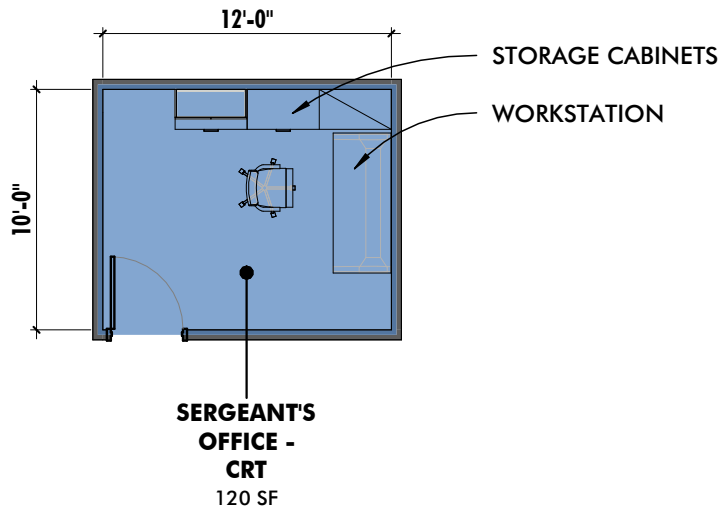

SERGEANT'S OFFICE - CRT

BALTIMORE POLICE DEPARTMENT

COPPIN STATE PUBLIC SAFETY BUILDING



10839-D PHILADELPHIA RD
WHITE MARSH, MD 21162

410-344-1460
INFO@MWSARCH.COM
WWW.MWSARCH.COM

JOB NO:22-002

DWG ISSUED ON:
09/27/2022

DWG SCALE:
1/8" = 1'-0"

DWG NUMBER:
PPR-028

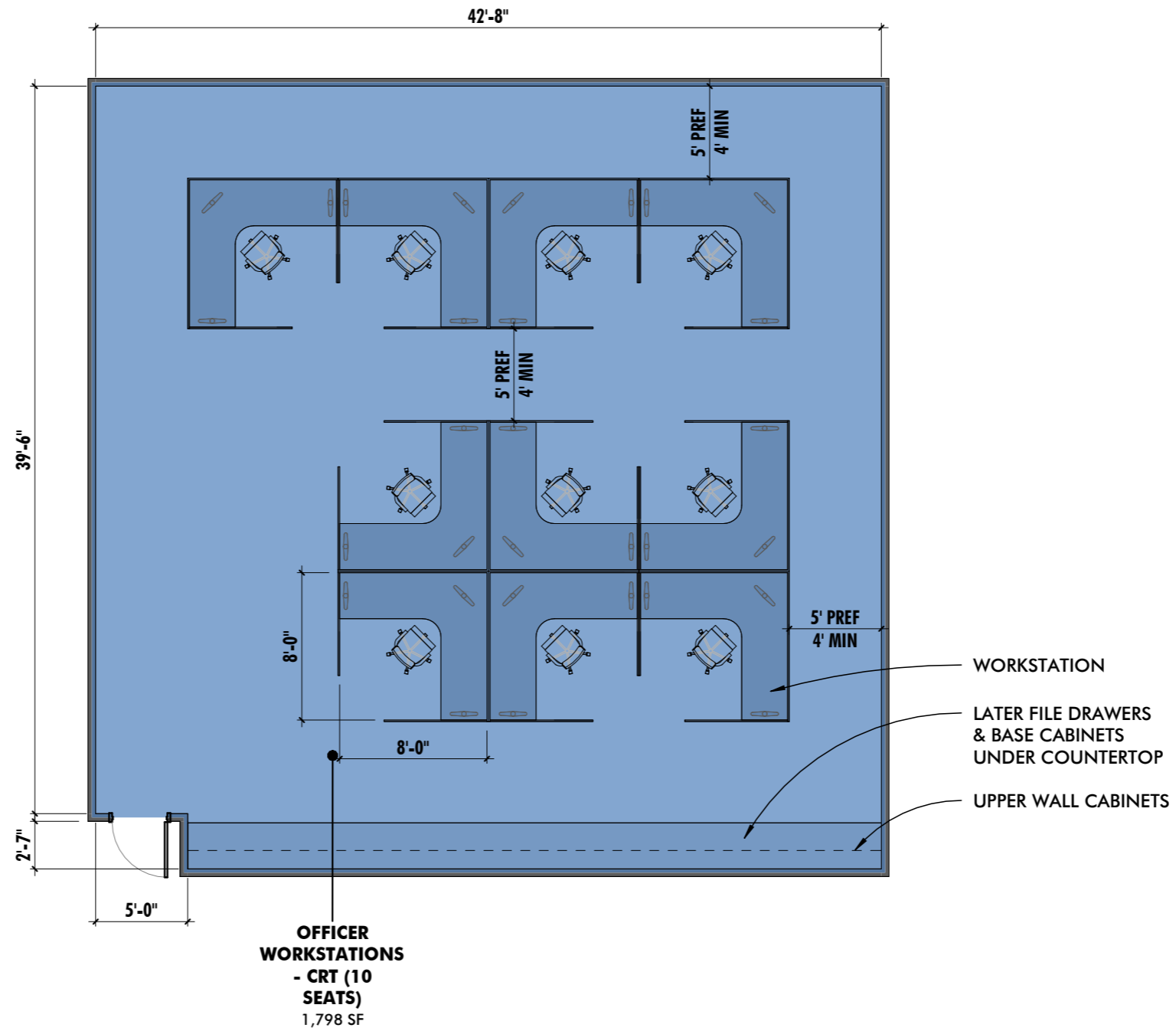

OFFICER WORKSTATIONS - CRT
BALTIMORE POLICE DEPARTMENT
COPPIN STATE PUBLIC SAFETY BUILDING



10839-D PHILADELPHIA RD
 WHITE MARSH, MD 21162
 410-344-1460
 INFO@MWSARCH.COM
 WWW.MWSARCH.COM

JOB NO:22-002

DWG ISSUED ON:
09/27/2022

DWG SCALE:
 1/8" = 1'-0"

DWG NUMBER:
PPR-029

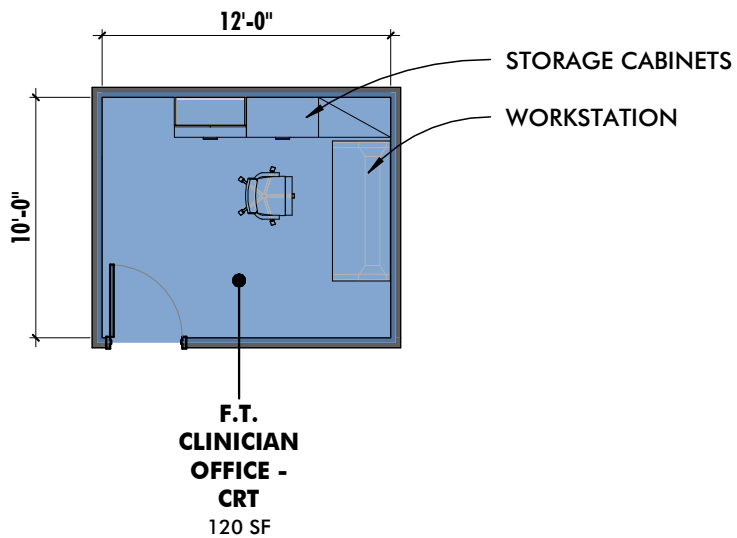

F.T CLINICIAN OFFICE - CRT
BALTIMORE POLICE DEPARTMENT
COPPIN STATE PUBLIC SAFETY BUILDING



10839-D PHILADELPHIA RD
 WHITE MARSH, MD 21162
 410-344-1460
 INFO@MWSARCH.COM
 WWW.MWSARCH.COM

JOB NO:22-002

DWG ISSUED ON:
09/27/2022

DWG SCALE:
1/8" = 1'-0"

DWG NUMBER:
PPR-030

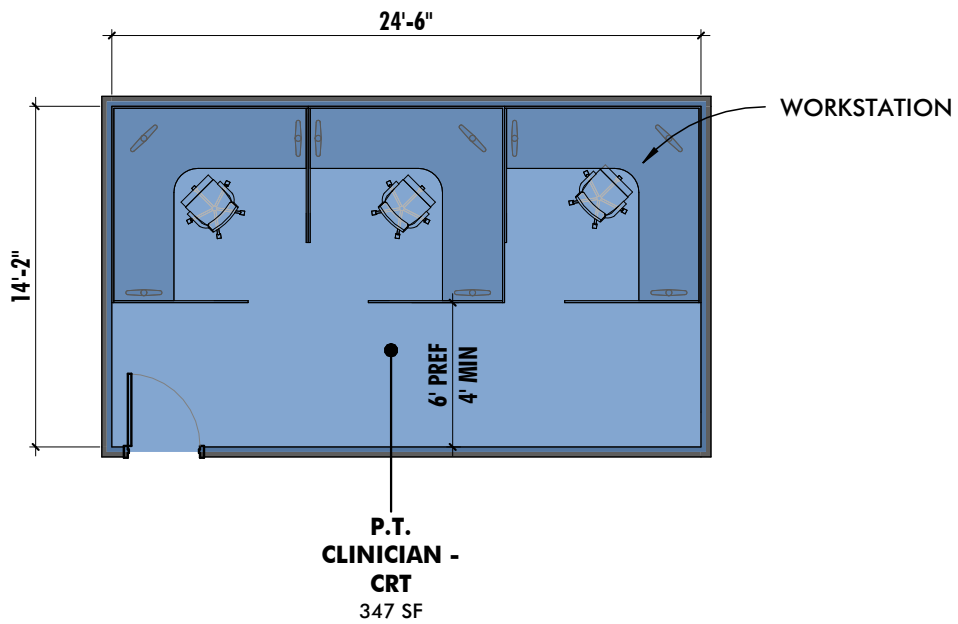

P.T. CLINICIAN OFFICE - CRT
BALTIMORE POLICE DEPARTMENT
COPPIN STATE PUBLIC SAFETY BUILDING



10839-D PHILADELPHIA RD
 WHITE MARSH, MD 21162
 410-344-1460
 INFO@MWSARCH.COM
 WWW.MWSARCH.COM

JOB NO:22-002
 DWG ISSUED ON:
09/27/2022
 DWG SCALE:
1/8" = 1'-0"
 DWG NUMBER:
PPR-031

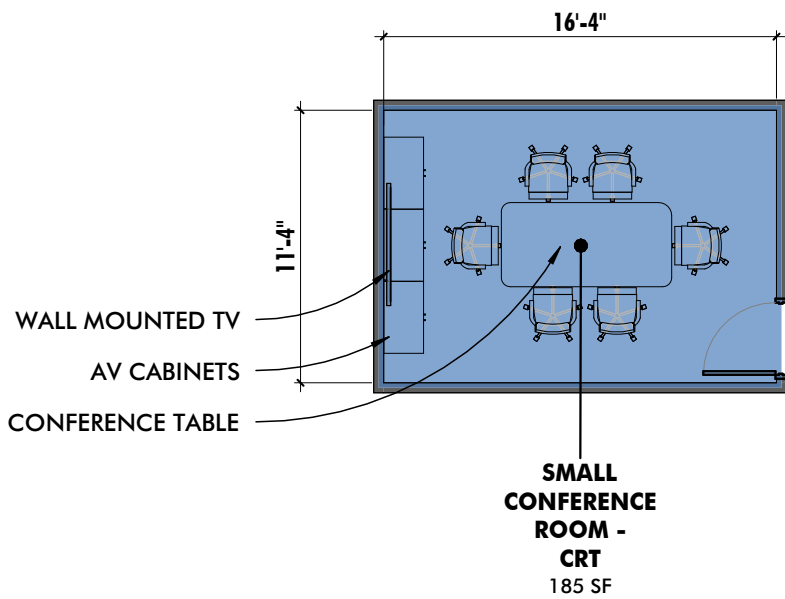

SMALL CONFERENCE ROOM - CRT

BALTIMORE POLICE DEPARTMENT

COPPIN STATE PUBLIC SAFETY BUILDING



10839-D PHILADELPHIA RD
WHITE MARSH, MD 21162

410-344-1460
INFO@MWSARCH.COM
WWW.MWSARCH.COM

JOB NO:22-002

DWG ISSUED ON:
09/27/2022

DWG SCALE:
1/8" = 1'-0"

DWG NUMBER:
PPR-032

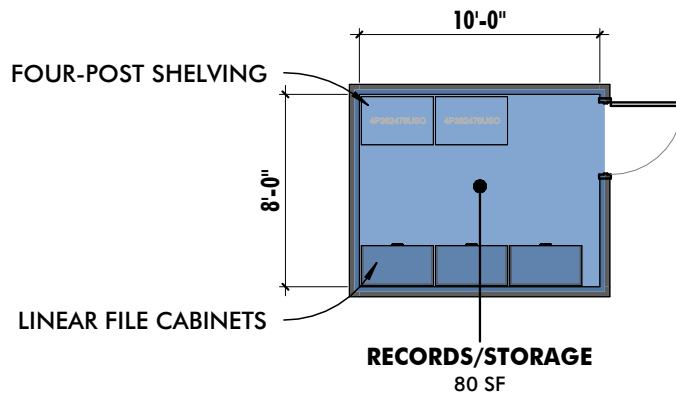

RECORDS/STORAGE - CRT

BALTIMORE POLICE DEPARTMENT

COPPIN STATE PUBLIC SAFETY BUILDING



10839-D PHILADELPHIA RD
WHITE MARSH, MD 21162

410-344-1460
INFO@MWSARCH.COM
WWW.MWSARCH.COM

JOB NO:22-002

DWG ISSUED ON:
09/27/2022

DWG SCALE:
1/8" = 1'-0"

DWG NUMBER:
PPR-033

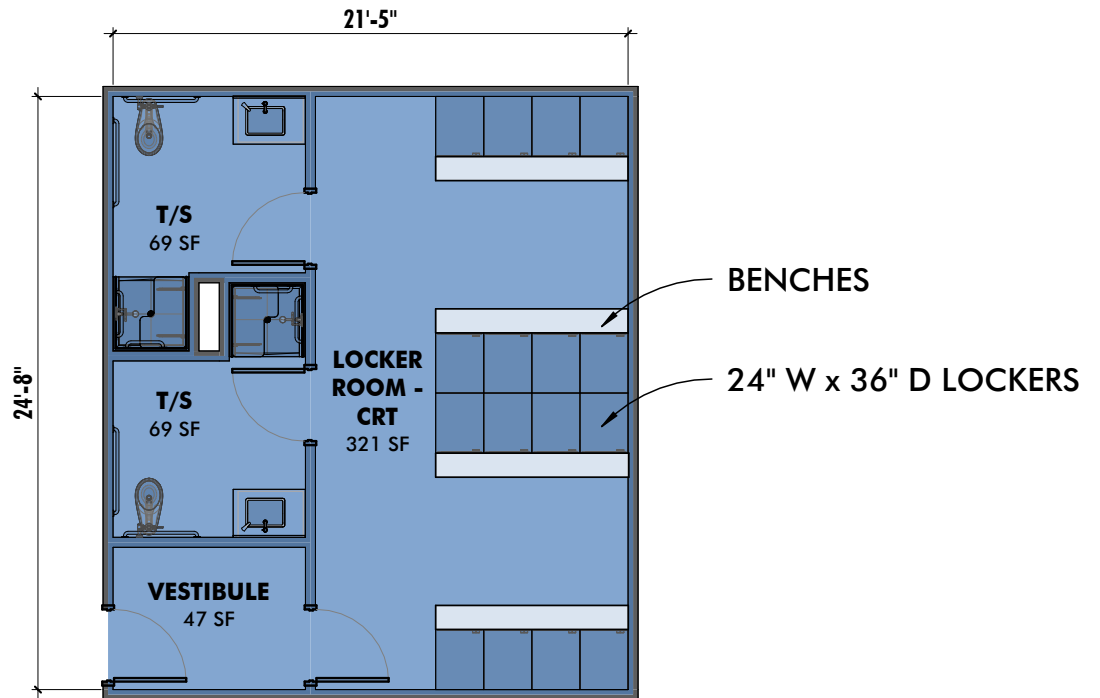

LOCKERS - CRT

BALTIMORE POLICE DEPARTMENT

COPPIN STATE PUBLIC SAFETY BUILDING



10839-D PHILADELPHIA RD
WHITE MARSH, MD 21162

410-344-1460
INFO@MWSARCH.COM
WWW.MWSARCH.COM

JOB NO:22-002

DWG ISSUED ON:
09/27/2022

DWG SCALE:
1/8" = 1'-0"

DWG NUMBER:
PPR-034

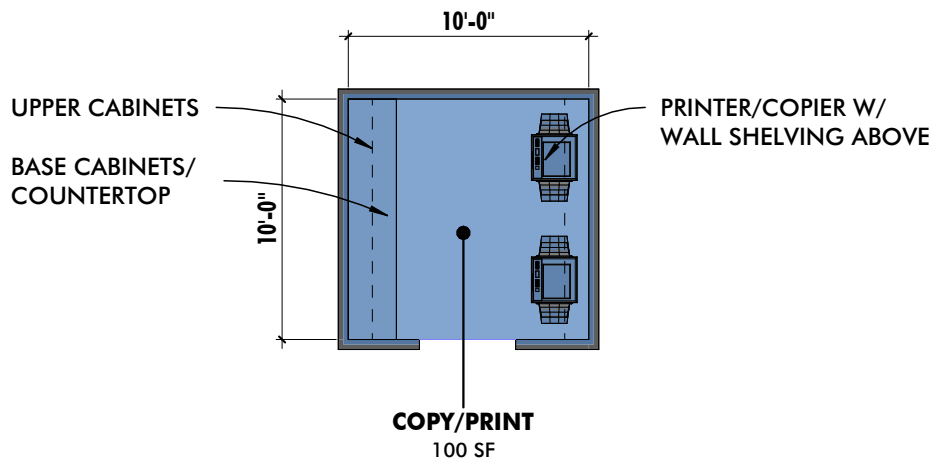

COPY/PRINT
BALTIMORE POLICE DEPARTMENT
COPPIN STATE PUBLIC SAFETY BUILDING



10839-D PHILADELPHIA RD
 WHITE MARSH, MD 21162
 410-344-1460
 INFO@MWSARCH.COM
 WWW.MWSARCH.COM

JOB NO:22-002
DWG ISSUED ON:
09/27/2022
DWG SCALE:
1/8" = 1'-0"
DWG NUMBER:
PPR-035

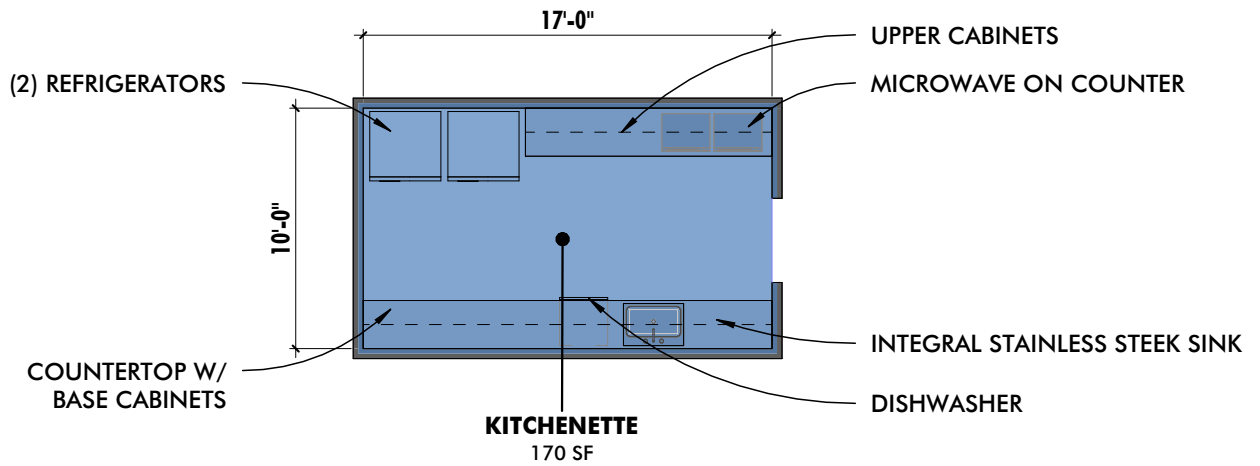

KITCHENETTE

BALTIMORE POLICE DEPARTMENT

COPPIN STATE PUBLIC SAFETY BUILDING



10839-D PHILADELPHIA RD
WHITE MARSH, MD 21162

410-344-1460
INFO@MWSARCH.COM
WWW.MWSARCH.COM

JOB NO:22-002

DWG ISSUED ON:
09/27/2022

DWG SCALE:
1/8" = 1'-0"

DWG NUMBER:
PPR-036

9/27/2022 8:07:44 AM

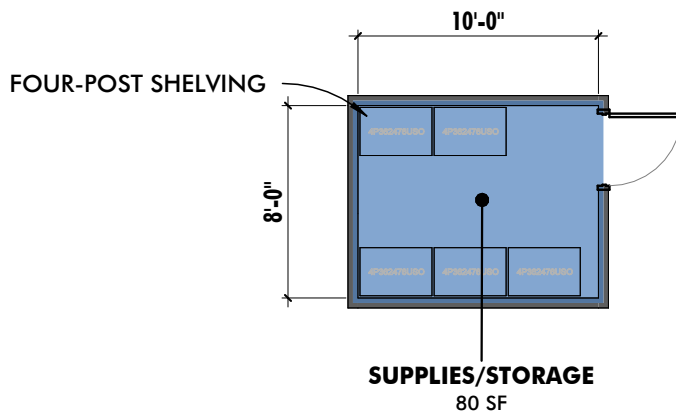

STORAGE - OFFICE SUPPLIES

BALTIMORE POLICE DEPARTMENT

COPPIN STATE PUBLIC SAFETY BUILDING



10839-D PHILADELPHIA RD
WHITE MARSH, MD 21162

410-344-1460
INFO@MWSARCH.COM
WWW.MWSARCH.COM

JOB NO:22-002

DWG ISSUED ON:
09/27/2022

DWG SCALE:
1/8" = 1'-0"

DWG NUMBER:
PPR-037

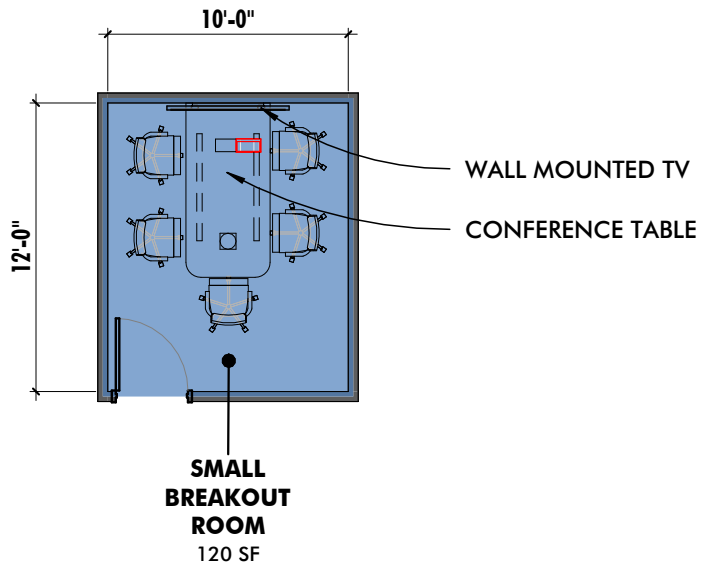

SMALL BREAKOUT ROOM

BALTIMORE POLICE DEPARTMENT

COPPIN STATE PUBLIC SAFETY BUILDING



10839-D PHILADELPHIA RD
WHITE MARSH, MD 21162

410-344-1460
INFO@MWSARCH.COM
WWW.MWSARCH.COM

JOB NO:22-002

DWG ISSUED ON:
09/27/2022

DWG SCALE:
1/8" = 1'-0"

DWG NUMBER:
PPR-045

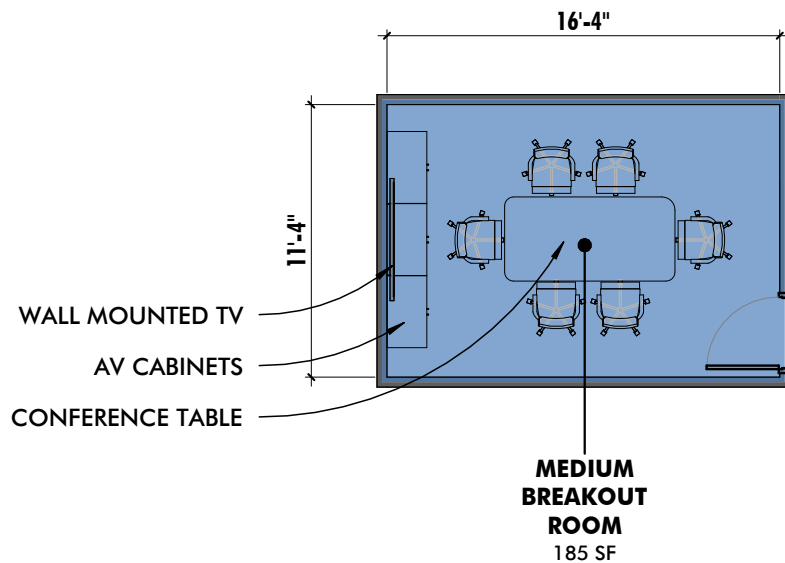

MEDIUM BREAKOUT ROOM

BALTIMORE POLICE DEPARTMENT

COPPIN STATE PUBLIC SAFETY BUILDING



10839-D PHILADELPHIA RD
WHITE MARSH, MD 21162

410-344-1460
INFO@MWSARCH.COM
WWW.MWSARCH.COM

JOB NO:22-002

DWG ISSUED ON:
09/27/2022

DWG SCALE:
1/8" = 1'-0"

DWG NUMBER:
PPR-046

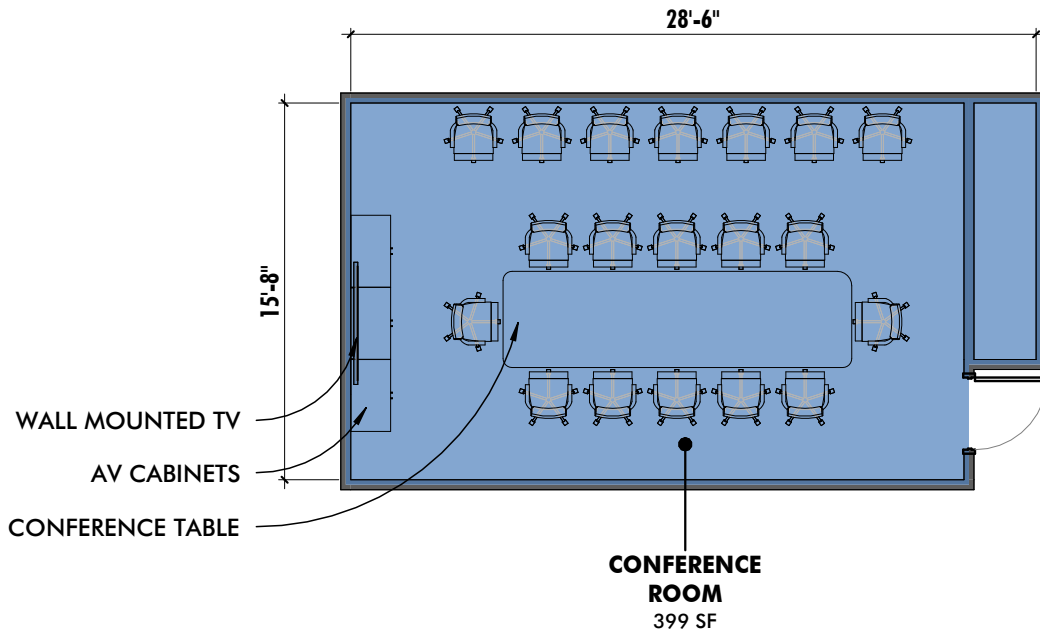

CONFERENCE ROOM (20 SEATS)

BALTIMORE POLICE DEPARTMENT

COPPIN STATE PUBLIC SAFETY BUILDING



10839-D PHILADELPHIA RD
WHITE MARSH, MD 21162

410-344-1460
INFO@MWSARCH.COM
WWW.MWSARCH.COM

JOB NO:22-002

DWG ISSUED ON:
09/27/2022

DWG SCALE:
1/8" = 1'-0"

DWG NUMBER:
PPR-047

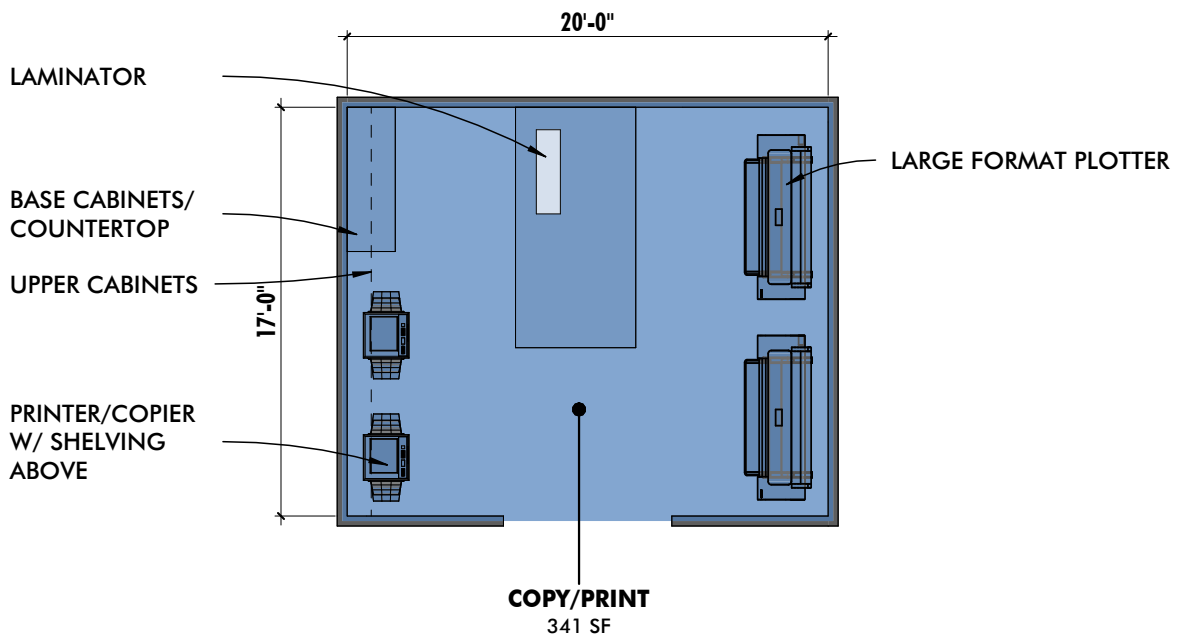

COPY/PRINT

BALTIMORE POLICE DEPARTMENT

COPPIN STATE PUBLIC SAFETY BUILDING



10839-D PHILADELPHIA RD
WHITE MARSH, MD 21162

410-344-1460
INFO@MWSARCH.COM
WWW.MWSARCH.COM

JOB NO:22-002

DWG ISSUED ON:
09/27/2022

DWG SCALE:
1/8" = 1'-0"

DWG NUMBER:
PPR-049

9/27/2022 8:07:51 AM

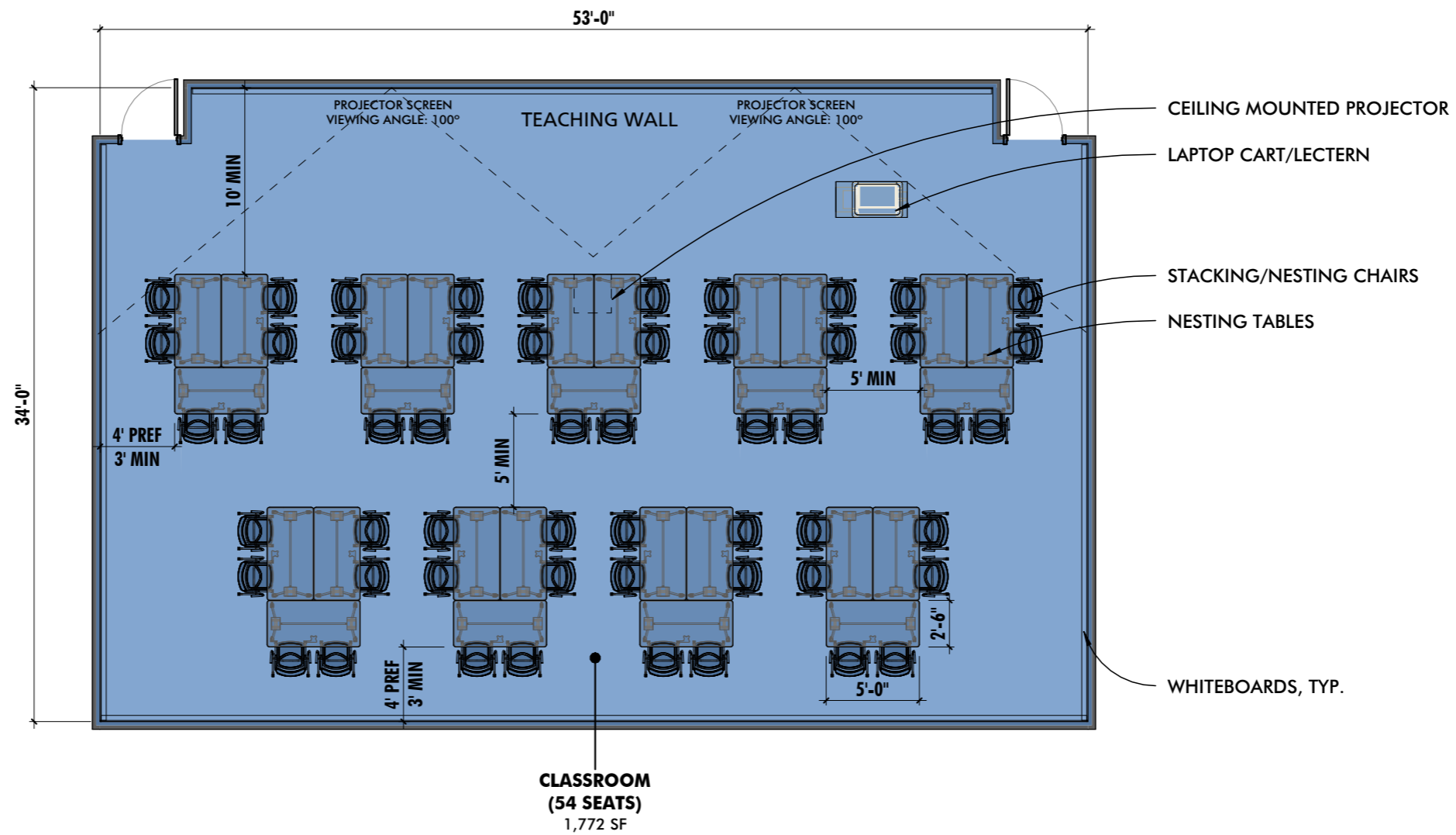

CLASSROOM (54 PERSON)
BALTIMORE POLICE DEPARTMENT
COPPIN STATE PUBLIC SAFETY BUILDING



10839-D PHILADELPHIA RD
 WHITE MARSH, MD 21162
 410-344-1460
 INFO@MWSARCH.COM
 WWW.MWSARCH.COM

JOB NO:22-002

DWG ISSUED ON:
09/27/2022

DWG SCALE:
 1/8" = 1'-0"

DWG NUMBER:
PPR-061

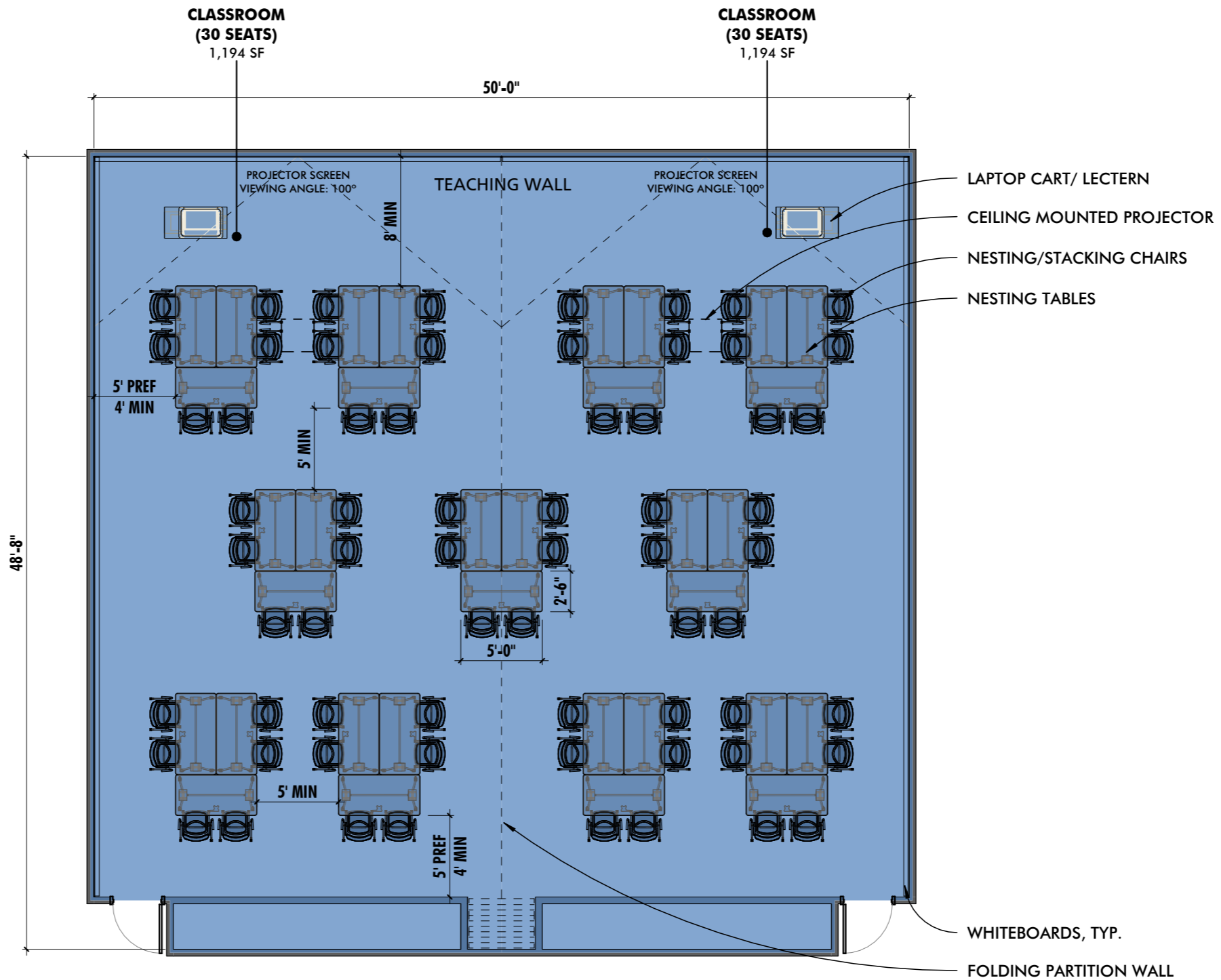

FLEX CLASSROOM (30/66 PERSON)
BALTIMORE POLICE DEPARTMENT
COPPIN STATE PUBLIC SAFETY BUILDING



10839-D PHILADELPHIA RD
 WHITE MARSH, MD 21162
 410-344-1460
 INFO@MWSARCH.COM
 WWW.MWSARCH.COM

JOB NO:22-002

DWG ISSUED ON:
09/27/2022

DWG SCALE:
1/8" = 1'-0"

DWG NUMBER:
PPR-062

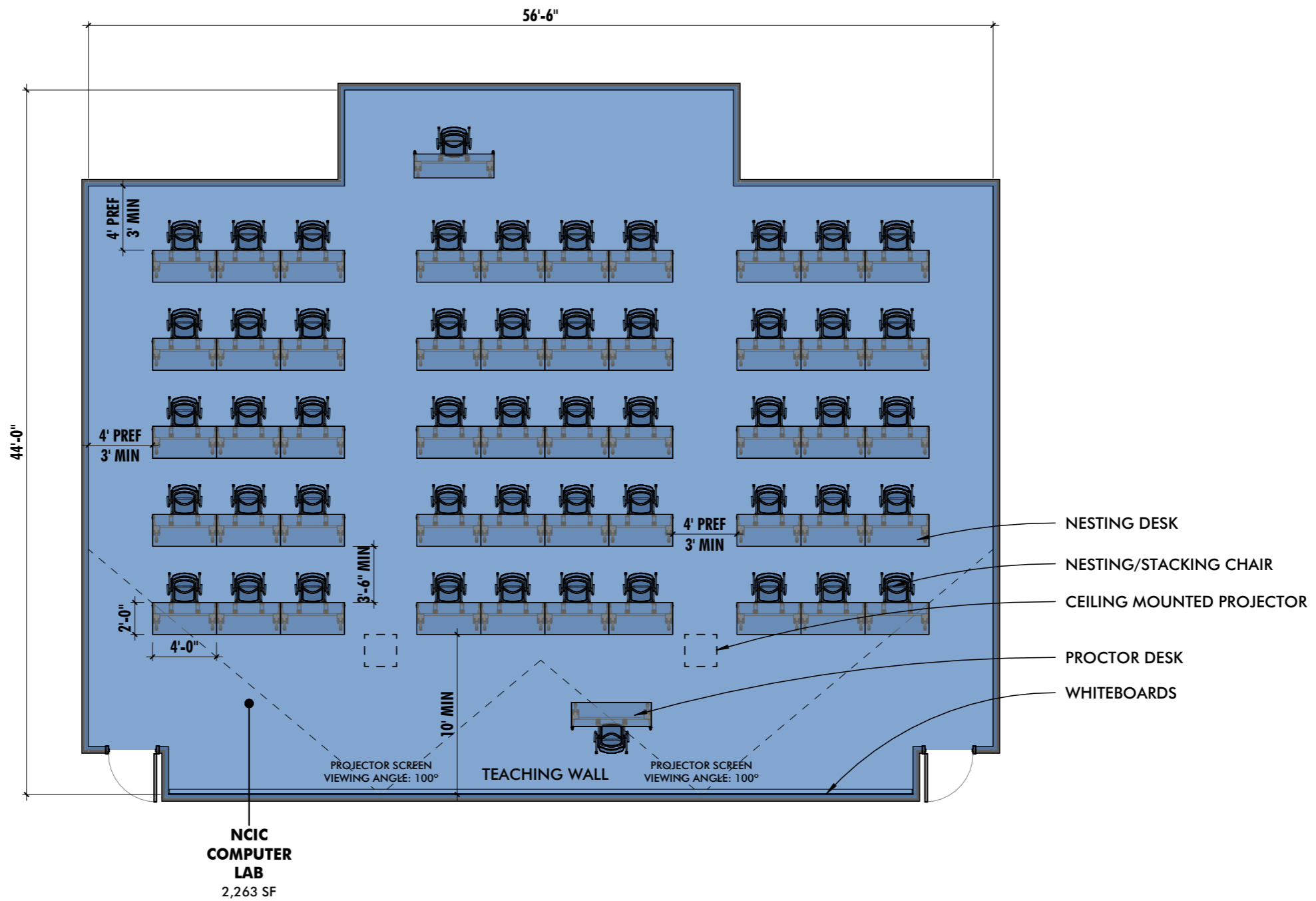

NCIC COMPUTER LAB (50 PERSON)
BALTIMORE POLICE DEPARTMENT
COPPIN STATE PUBLIC SAFETY BUILDING



10839-D PHILADELPHIA RD
 WHITE MARSH, MD 21162
 410-344-1460
 INFO@MWSARCH.COM
 WWW.MWSARCH.COM

JOB NO:22-002
 DWG ISSUED ON:
09/27/2022
 DWG SCALE:
 1/8" = 1'-0"
 DWG NUMBER:
PPR-063

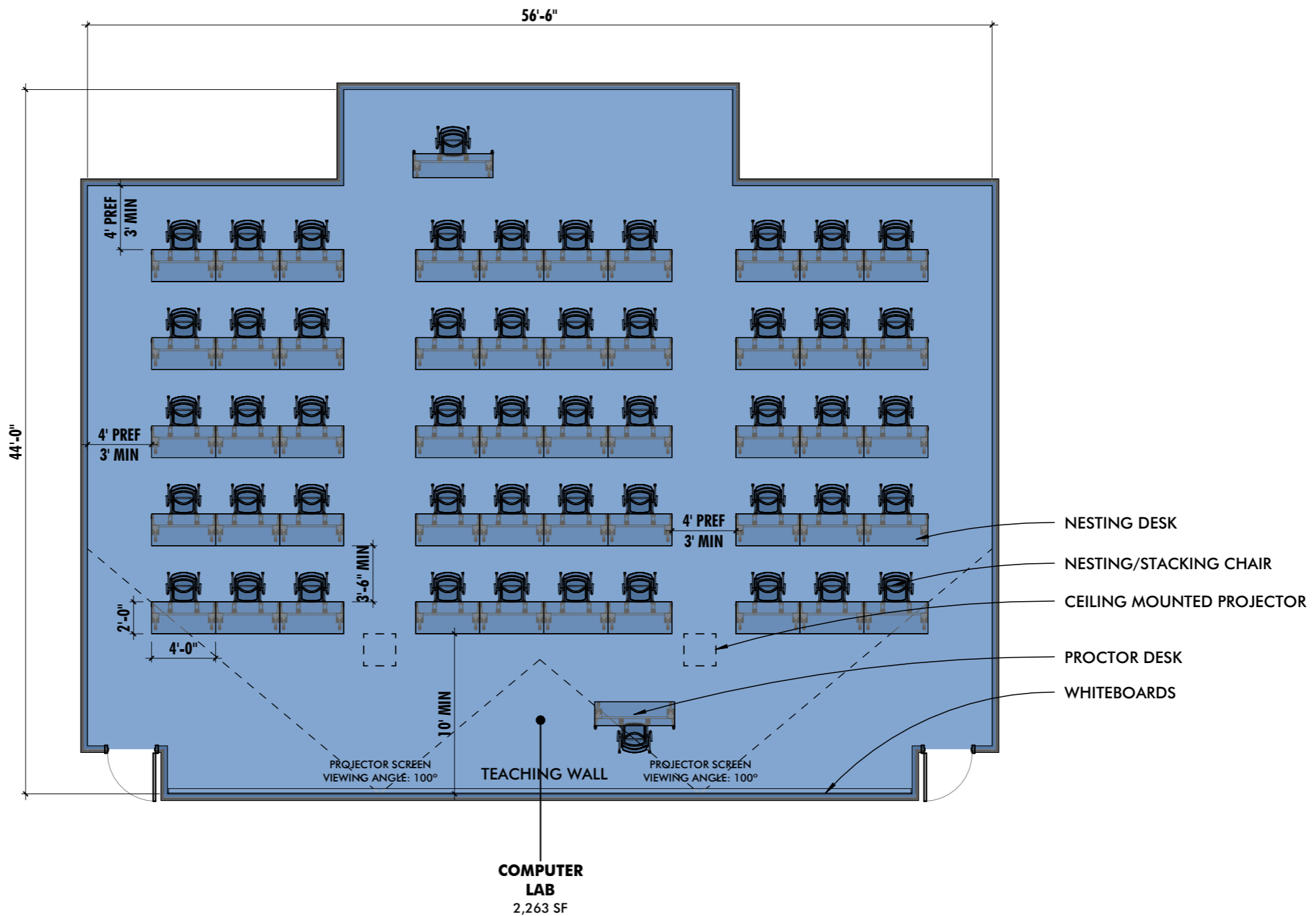

COMPUTER LAB (50 PERSON)
BALTIMORE POLICE DEPARTMENT
COPPIN STATE PUBLIC SAFETY BUILDING



10839-D PHILADELPHIA RD
 WHITE MARSH, MD 21162
 410-344-1460
 INFO@MWSARCH.COM
 WWW.MWSARCH.COM

JOB NO:22-002

DWG ISSUED ON:
09/27/2022

DWG SCALE:
 1/8" = 1'-0"

DWG NUMBER:
PPR-064

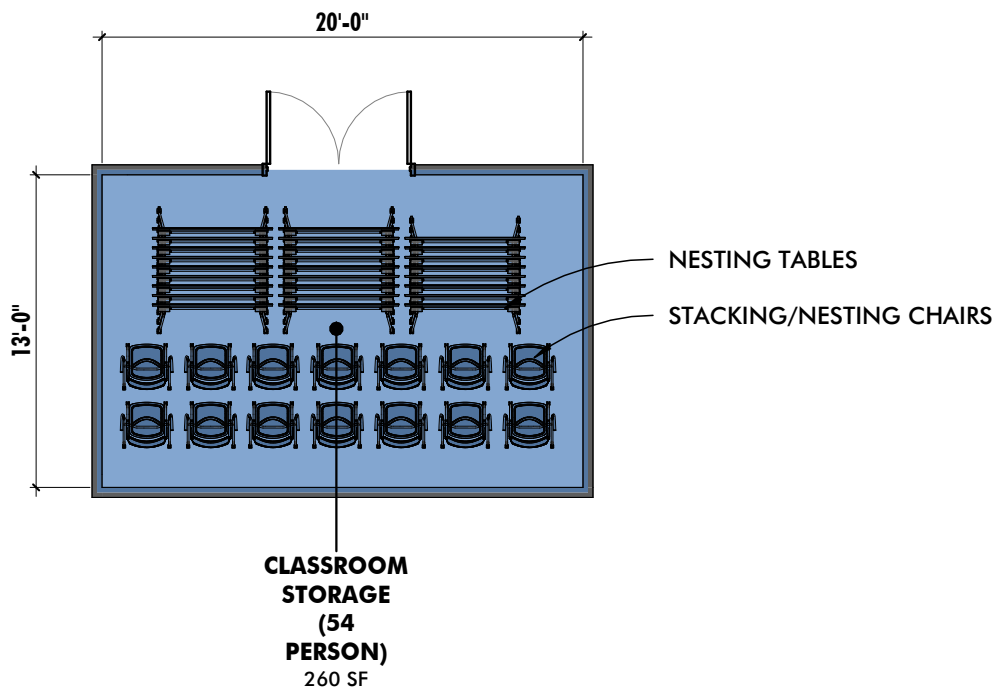

CLASSROOM STORAGE (54 PERSON)
BALTIMORE POLICE DEPARTMENT
COPPIN STATE PUBLIC SAFETY BUILDING



10839-D PHILADELPHIA RD
 WHITE MARSH, MD 21162
 410-344-1460
 INFO@MWSARCH.COM
 WWW.MWSARCH.COM

JOB NO:22-002
DWG ISSUED ON:
09/27/2022
DWG SCALE:
1/8" = 1'-0"
DWG NUMBER:
PPR-075

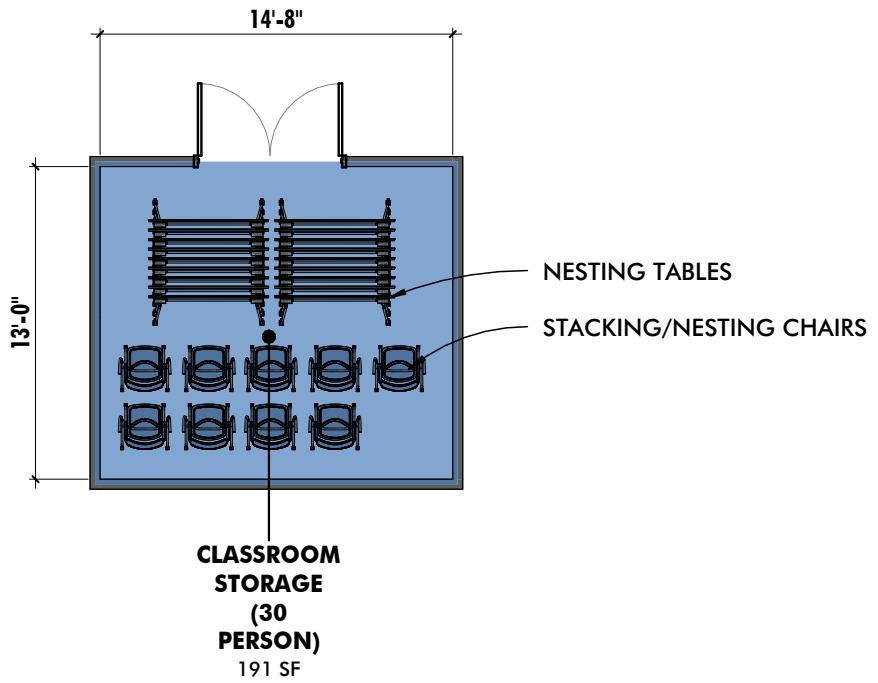

CLASSROOM STORAGE (30 PERSON)

BALTIMORE POLICE DEPARTMENT

COPPIN STATE PUBLIC SAFETY BUILDING



10839-D PHILADELPHIA RD
WHITE MARSH, MD 21162

410-344-1460
INFO@MWSARCH.COM
WWW.MWSARCH.COM

JOB NO:22-002

**DWG ISSUED ON:
09/27/2022**

**DWG SCALE:
1/8" = 1'-0"**

**DWG NUMBER:
PPR-076**

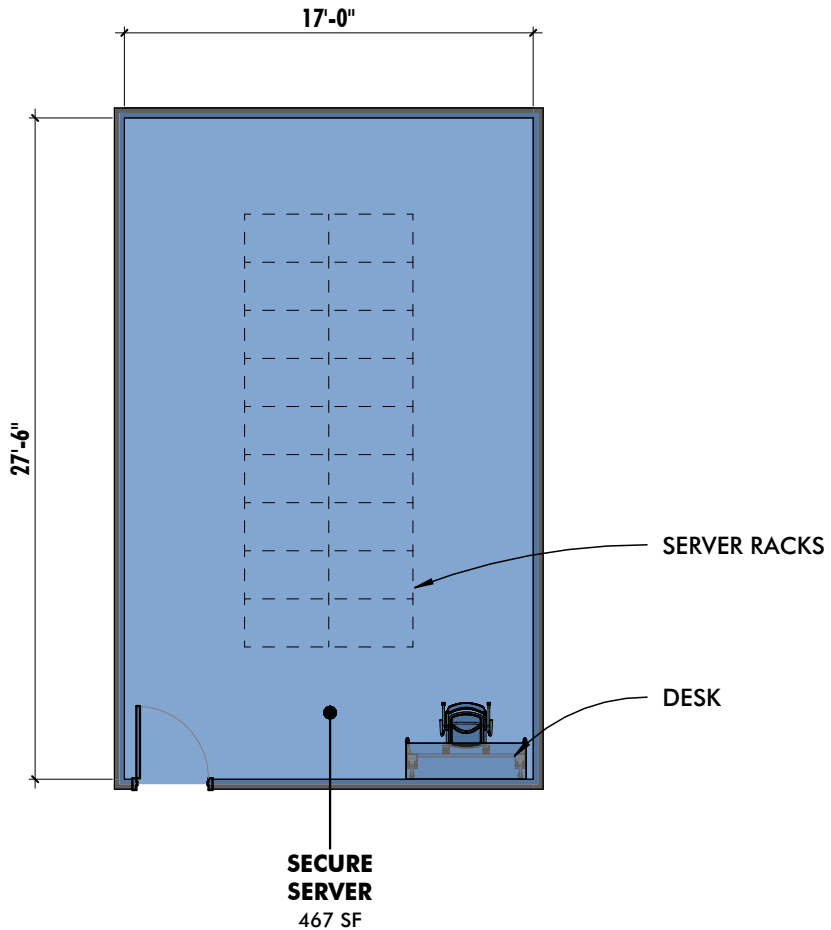

SECURE SERVER
BALTIMORE POLICE DEPARTMENT
COPPIN STATE PUBLIC SAFETY BUILDING



10839-D PHILADELPHIA RD
 WHITE MARSH, MD 21162
 410-344-1460
 INFO@MWSARCH.COM
 WWW.MWSARCH.COM

JOB NO:22-002
DWG ISSUED ON:
09/27/2022
DWG SCALE:
1/8" = 1'-0"
DWG NUMBER:
PPR-077

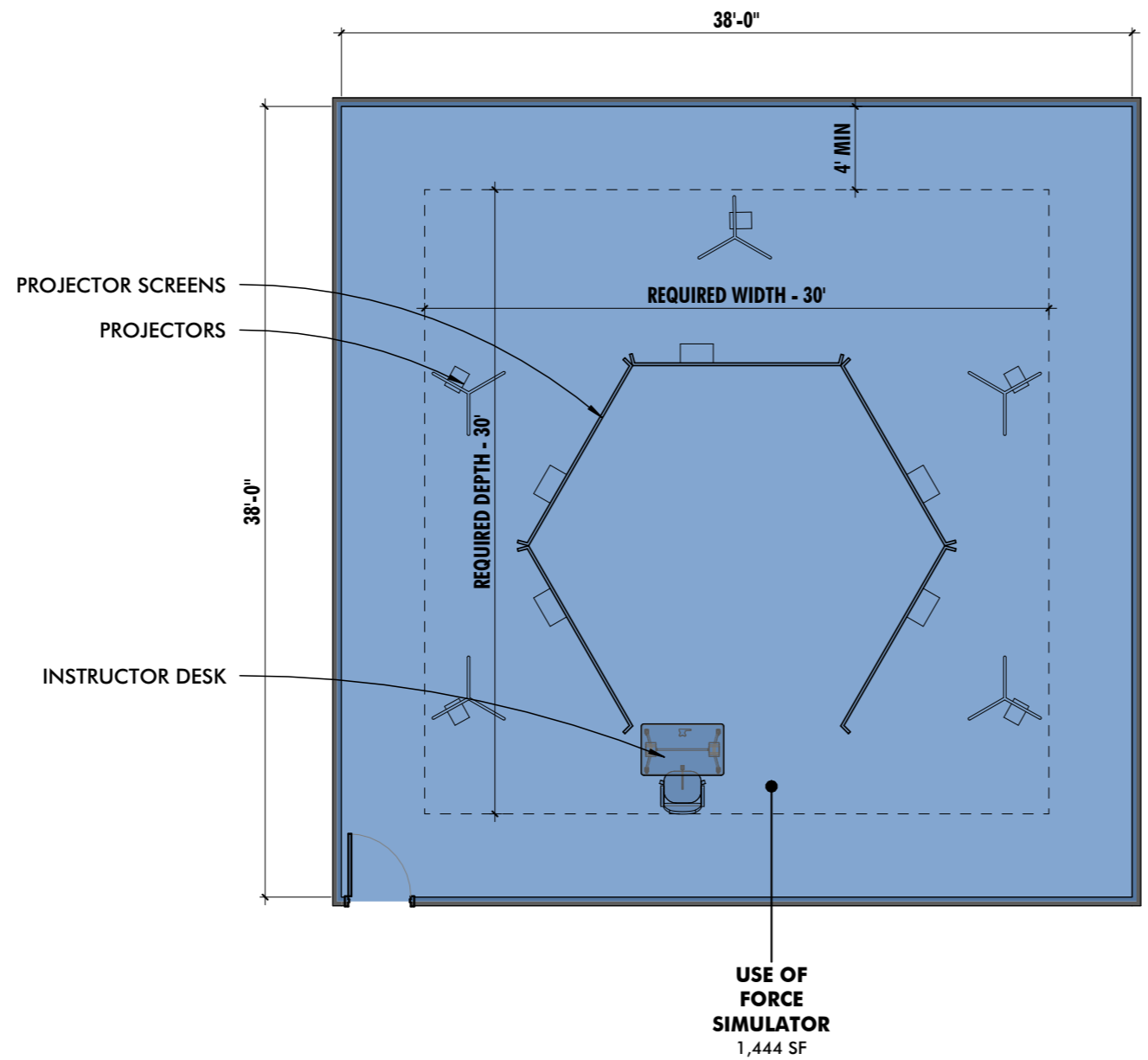

USE OF FORCE SIMULATOR
BALTIMORE POLICE DEPARTMENT
COPPIN STATE PUBLIC SAFETY BUILDING



10839-D PHILADELPHIA RD
 WHITE MARSH, MD 21162
 410-344-1460
 INFO@MWSARCH.COM
 WWW.MWSARCH.COM

JOB NO:22-002

DWG ISSUED ON:
09/27/2022

DWG SCALE:
1/8" = 1'-0"

DWG NUMBER:
PPR-088

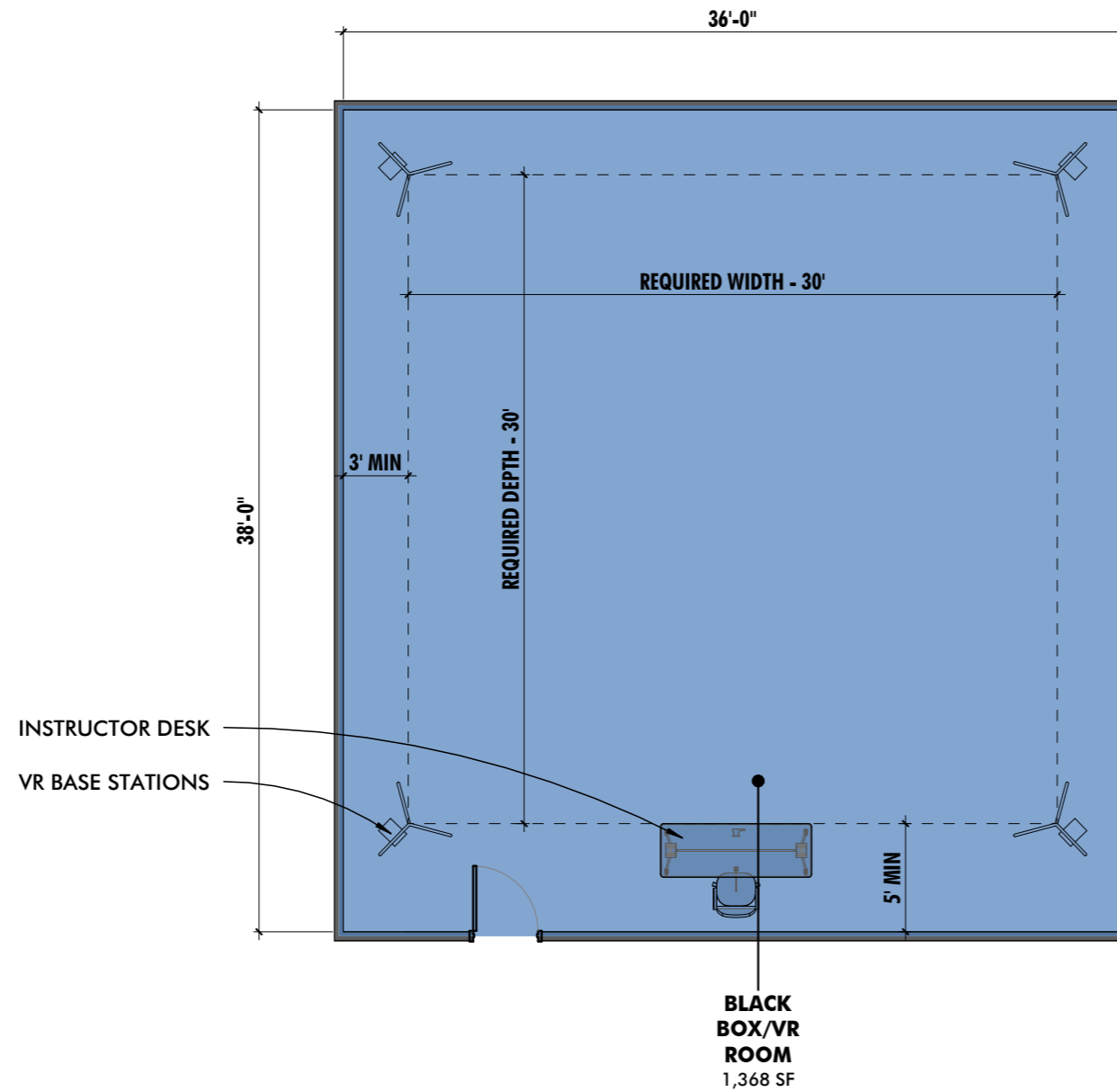

BLACK BOX/VR ROOM
BALTIMORE POLICE DEPARTMENT
COPPIN STATE PUBLIC SAFETY BUILDING



10839-D PHILADELPHIA RD
 WHITE MARSH, MD 21162
 410-344-1460
 INFO@MWSARCH.COM
 WWW.MWSARCH.COM

JOB NO:22-002

DWG ISSUED ON:
09/27/2022

DWG SCALE:
 1/8" = 1'-0"

DWG NUMBER:
PPR-089

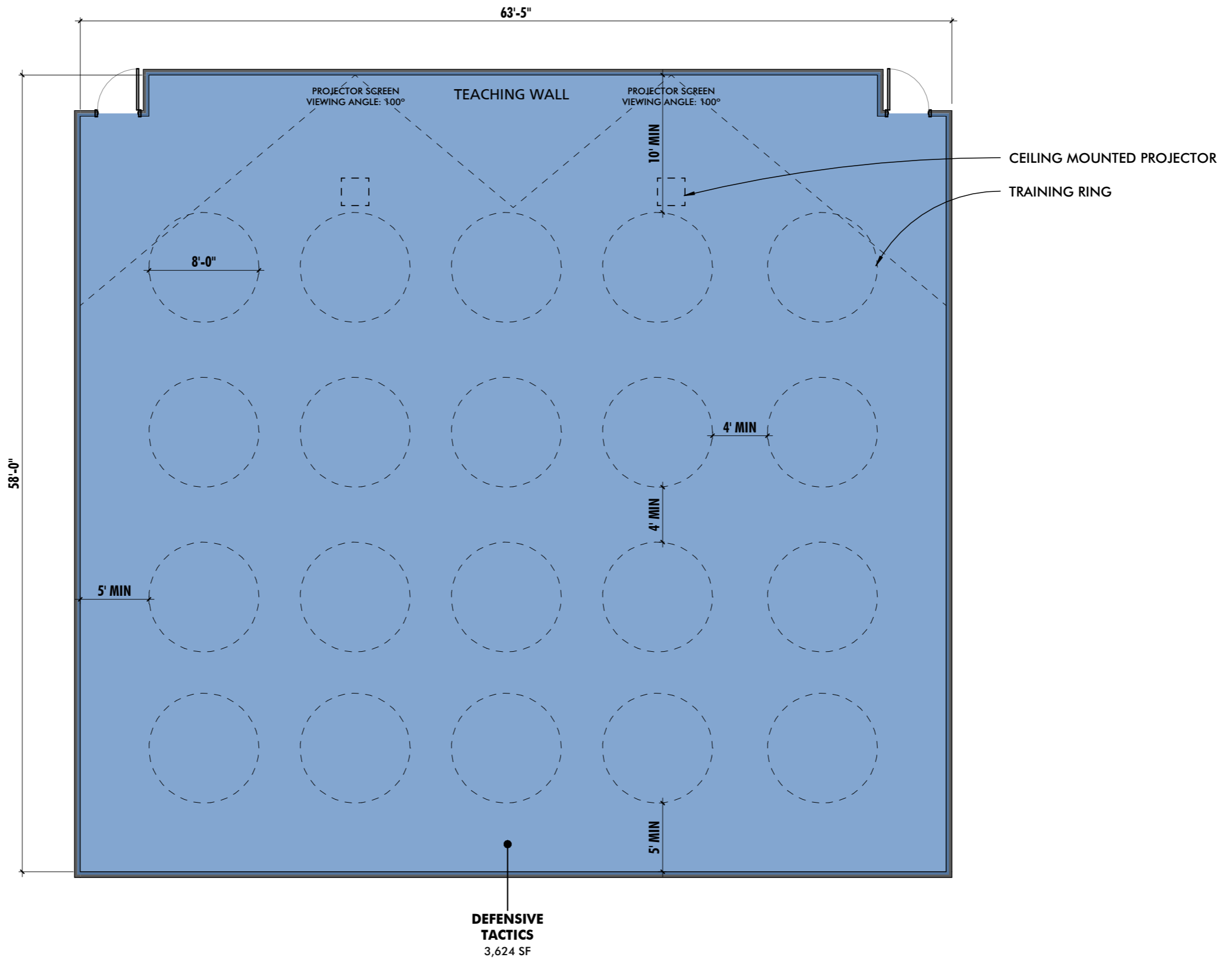

DEFENSIVE TACTICS
BALTIMORE POLICE DEPARTMENT
COPPIN STATE PUBLIC SAFETY BUILDING

MANN'S WOODWARD STUDIOS
 ARCHITECTURE + MASTER PLANNING

10839-D PHILADELPHIA RD
 WHITE MARSH, MD 21162
 410-344-1460
 INFO@MWSARCH.COM
 WWW.MWSARCH.COM

JOB NO:22-002
 DWG ISSUED ON:
09/27/2022
 DWG SCALE:
 1/8" = 1'-0"
 DWG NUMBER:
PPR-095

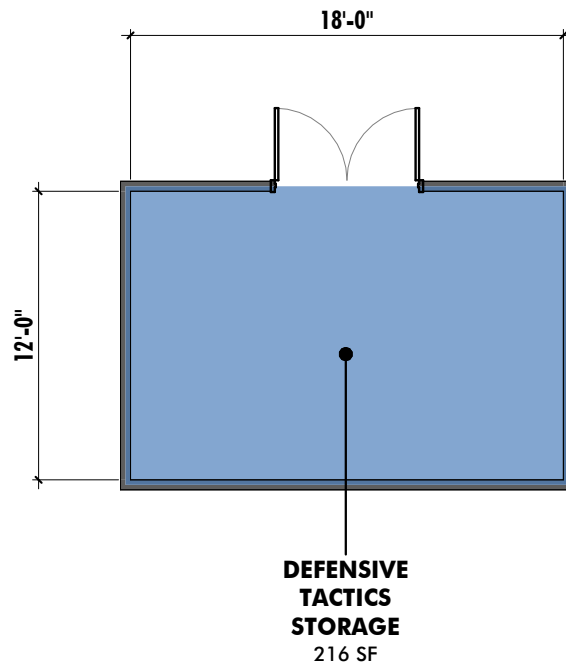

DEFENSIVE TACTICS STORAGE
BALTIMORE POLICE DEPARTMENT
COPPIN STATE PUBLIC SAFETY BUILDING



10839-D PHILADELPHIA RD
 WHITE MARSH, MD 21162
 410-344-1460
 INFO@MWSARCH.COM
 WWW.MWSARCH.COM

JOB NO:22-002
DWG ISSUED ON:
09/27/2022
DWG SCALE:
1/8" = 1'-0"
DWG NUMBER:
PPR-096

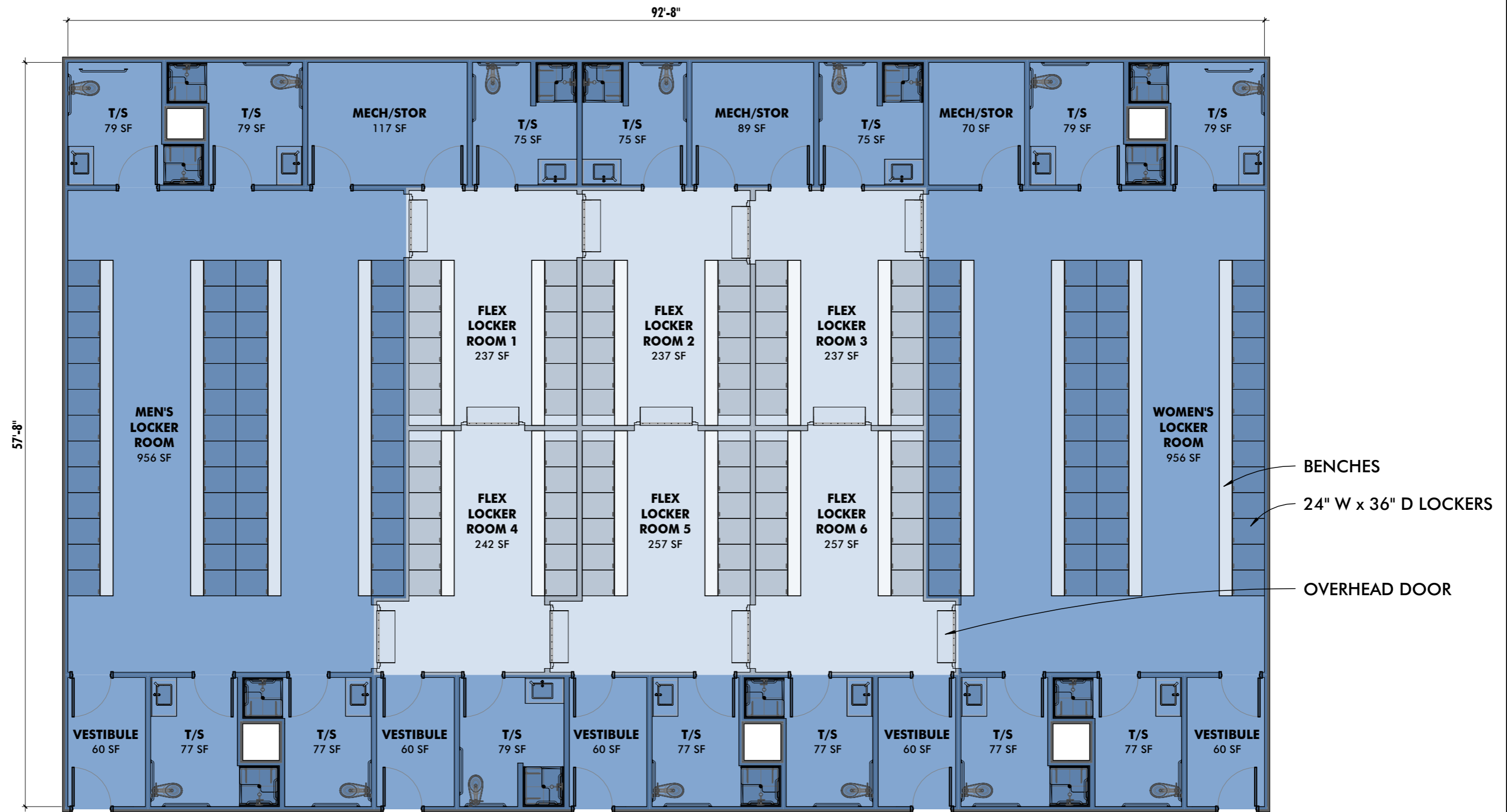

RECRUIT LOCKERS
BALTIMORE POLICE DEPARTMENT
COPPIN STATE PUBLIC SAFETY BUILDING



10839-D PHILADELPHIA RD
 WHITE MARSH, MD 21162
 410-344-1460
 INFO@MWSARCH.COM
 WWW.MWSARCH.COM

JOB NO:22-002
 DWG ISSUED ON:
09/27/2022
 DWG SCALE:
 1/8" = 1'-0"
 DWG NUMBER:
PPR-102

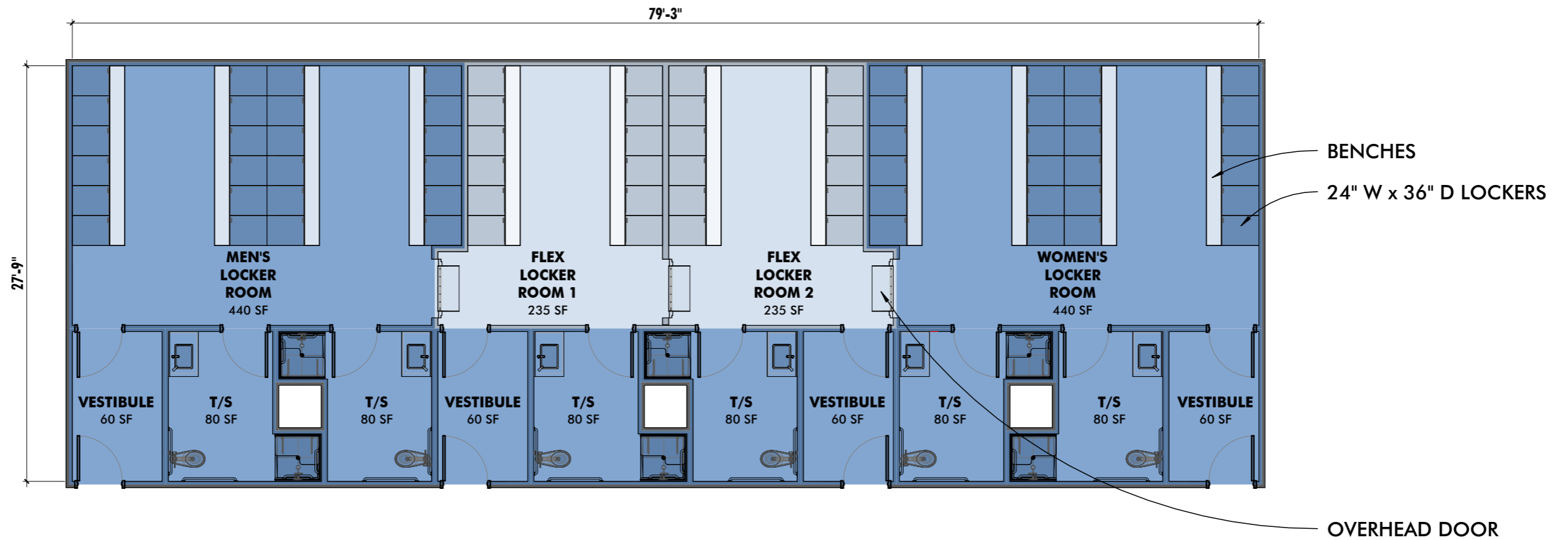

INSTRUCTOR LOCKERS
BALTIMORE POLICE DEPARTMENT
COPPIN STATE PUBLIC SAFETY BUILDING



10839-D PHILADELPHIA RD
 WHITE MARSH, MD 21162
 410-344-1460
 INFO@MWSARCH.COM
 WWW.MWSARCH.COM

JOB NO:22-002

DWG ISSUED ON:
09/27/2022

DWG SCALE:
 1/8" = 1'-0"

DWG NUMBER:
PPR-103

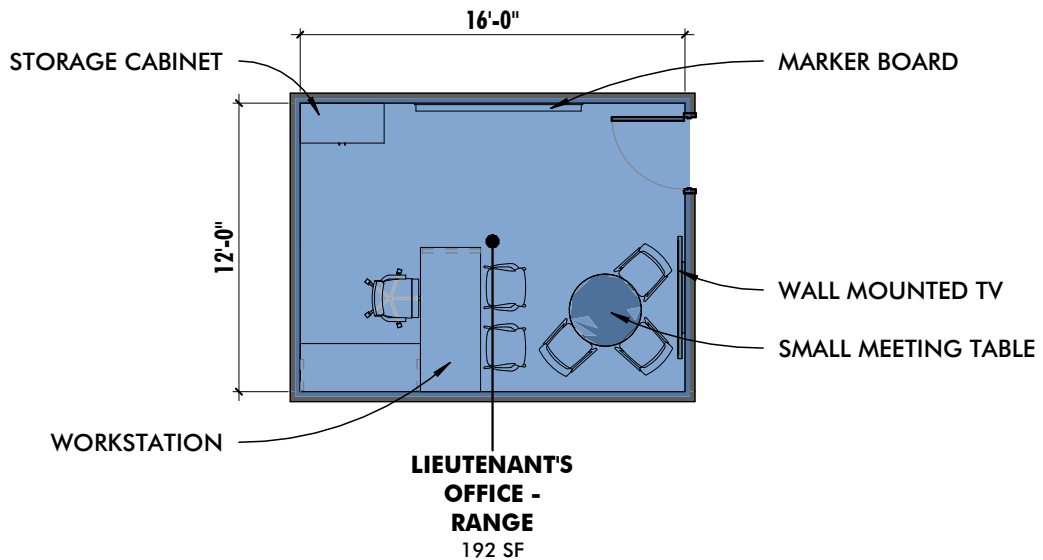

LIEUTENANT'S OFFICE - FIRING RANGE
BALTIMORE POLICE DEPARTMENT
COPPIN STATE PUBLIC SAFETY BUILDING



10839-D PHILADELPHIA RD
 WHITE MARSH, MD 21162
 410-344-1460
 INFO@MWSARCH.COM
 WWW.MWSARCH.COM

JOB NO:22-002
DWG ISSUED ON:
09/27/2022
DWG SCALE:
1/8" = 1'-0"
DWG NUMBER:
PPR-119

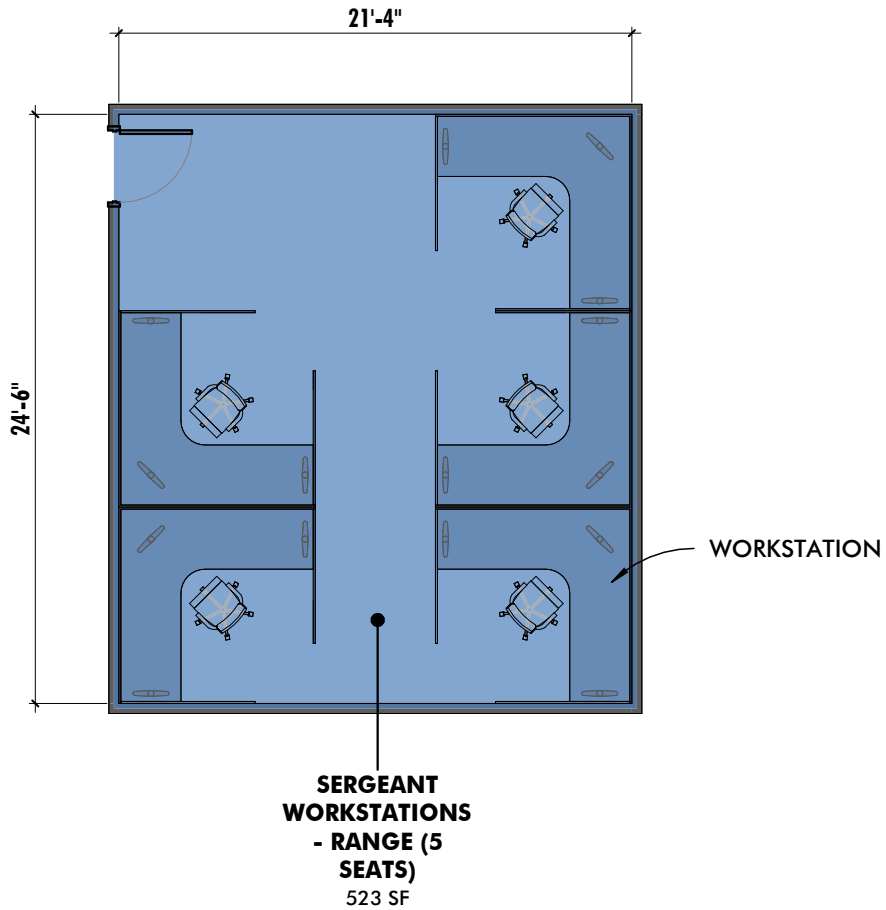

SERGEANT WORKSTATIONS - FIRING RANGE
BALTIMORE POLICE DEPARTMENT
COPPIN STATE PUBLIC SAFETY BUILDING



10839-D PHILADELPHIA RD
 WHITE MARSH, MD 21162
 410-344-1460
 INFO@MWSARCH.COM
 WWW.MWSARCH.COM

JOB NO:22-002
DWG ISSUED ON:
09/27/2022
DWG SCALE:
1/8" = 1'-0"
DWG NUMBER:
PPR-120

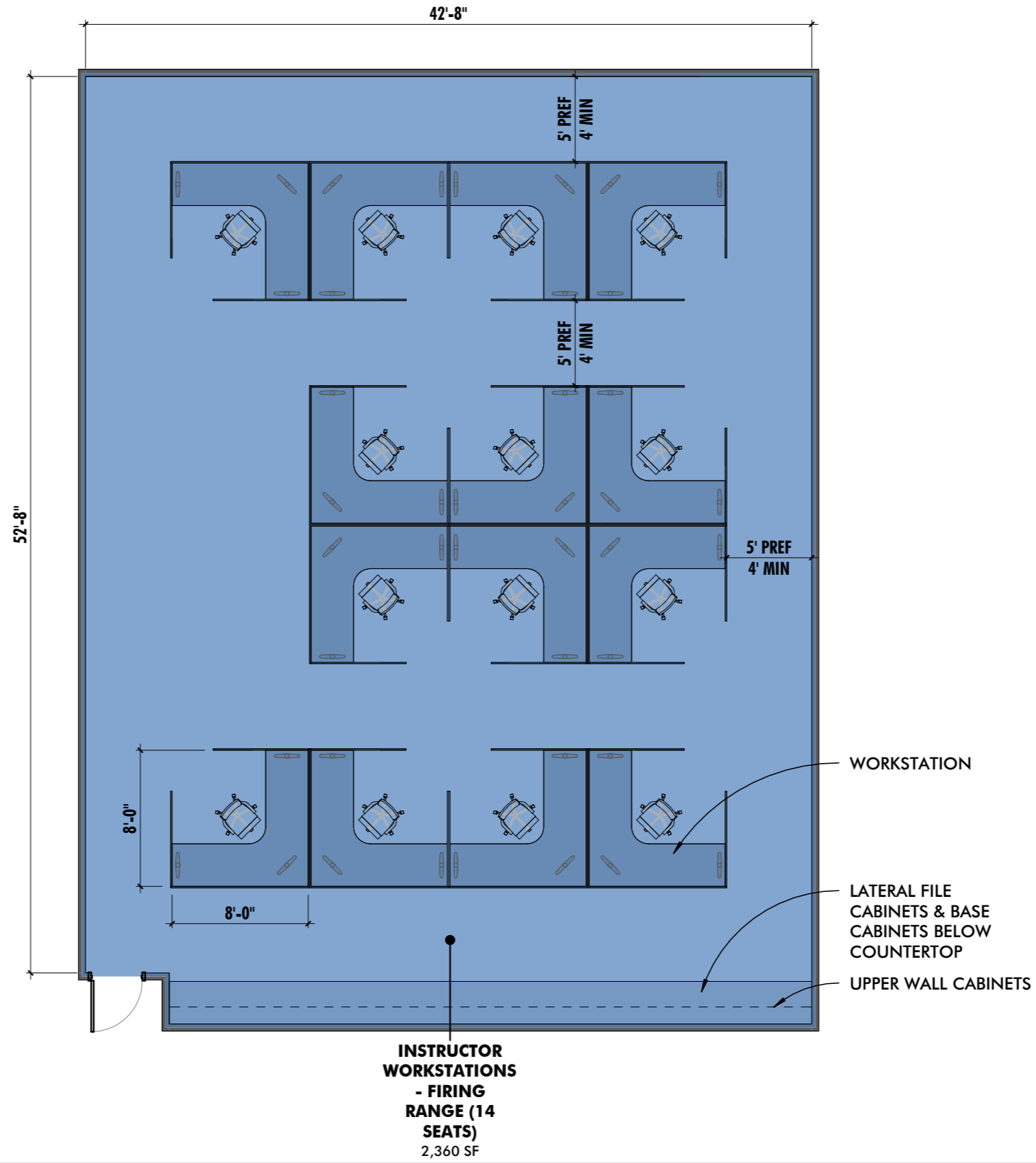

**INSTRUCTOR WORKSTATIONS
- FIRING RANGE (14 SEATS)
2,360 SF**

INSTRUCTOR WORKSTATIONS - FIRING RANGE
BALTIMORE POLICE DEPARTMENT
COPPIN STATE PUBLIC SAFETY BUILDING



10839-D PHILADELPHIA RD
 WHITE MARSH, MD 21162
 410-344-1460
 INFO@MWSARCH.COM
 WWW.MWSARCH.COM

JOB NO:22-002

DWG ISSUED ON:
09/27/2022

DWG SCALE:
1/8" = 1'-0"

DWG NUMBER:
PPR-121

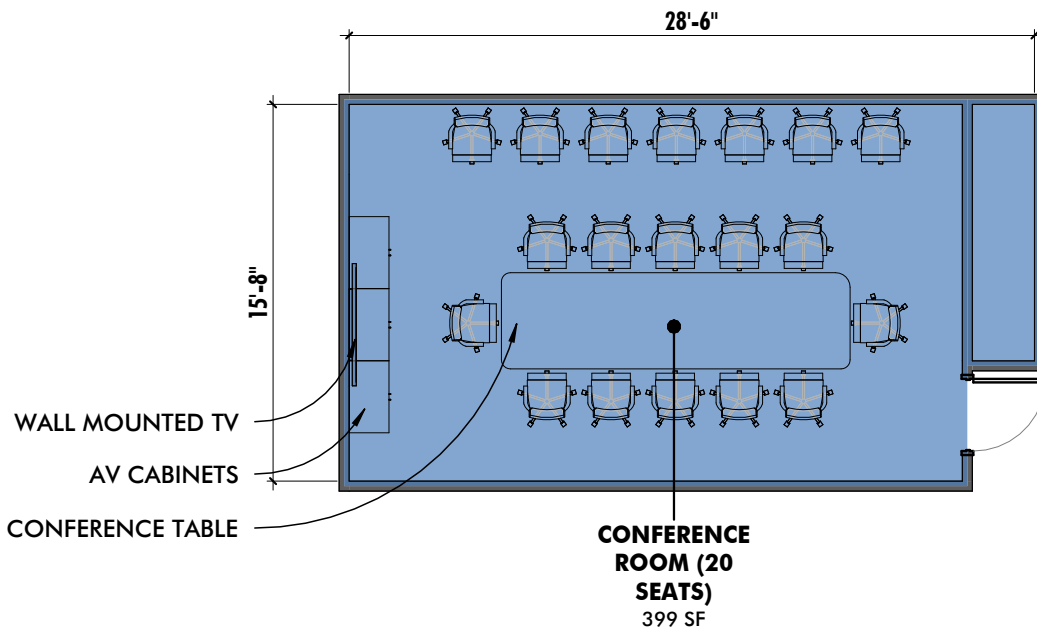

CONFERENCE ROOM - FIRING RANGE

BALTIMORE POLICE DEPARTMENT

COPPIN STATE PUBLIC SAFETY BUILDING



10839-D PHILADELPHIA RD
WHITE MARSH, MD 21162

410-344-1460
INFO@MWSARCH.COM
WWW.MWSARCH.COM

JOB NO:22-002

DWG ISSUED ON:
09/27/2022

DWG SCALE:
1/8" = 1'-0"

DWG NUMBER:
PPR-122

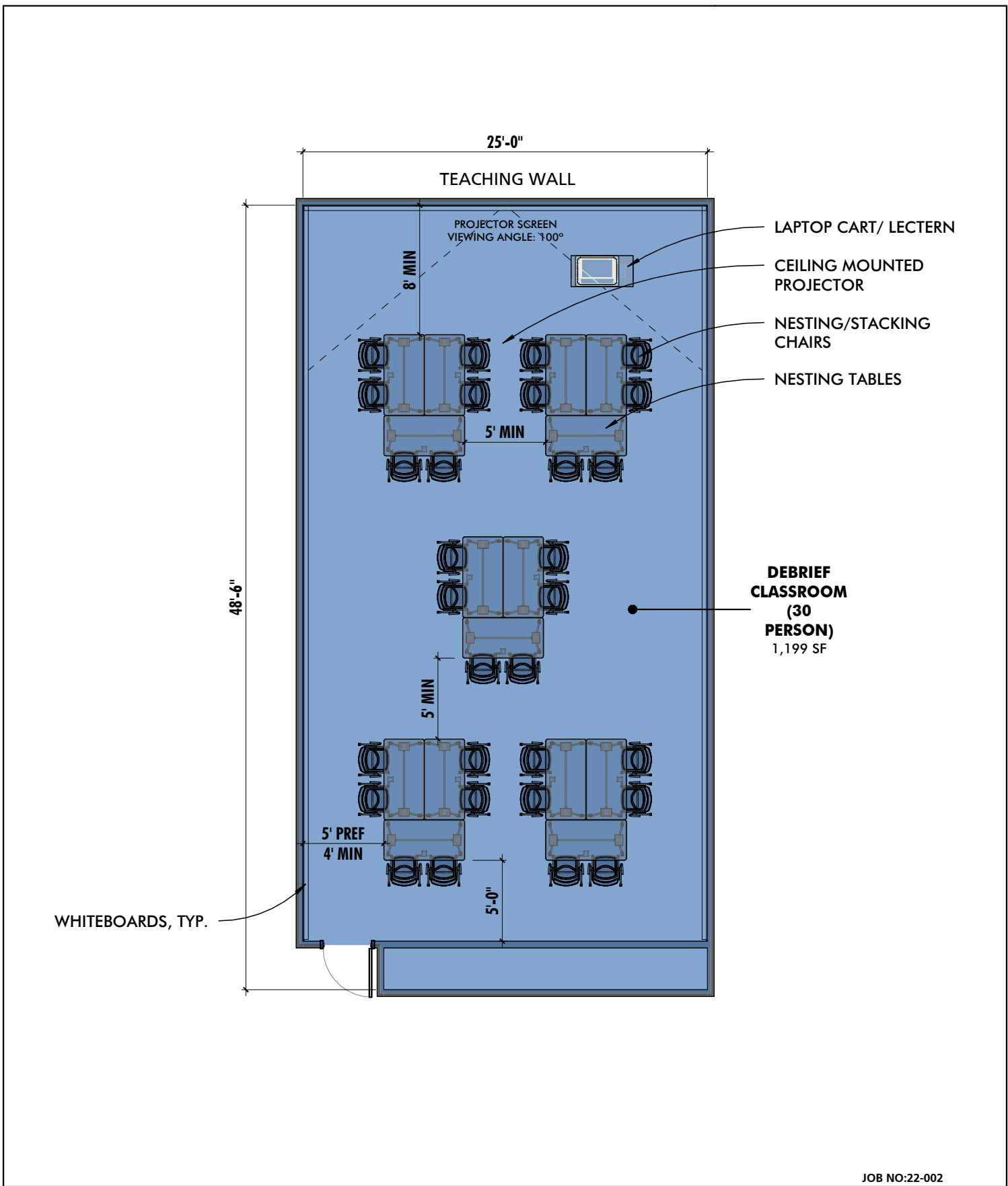

DEBRIEF CLASSROOM - FIRING RANGE
BALTIMORE POLICE DEPARTMENT
COPPIN STATE PUBLIC SAFETY BUILDING

MANN'S WOODWARD STUDIOS
 ARCHITECTURE + MASTER PLANNING

10839-D PHILADELPHIA RD
 WHITE MARSH, MD 21162

410-344-1460
 INFO@MWSARCH.COM
 WWW.MWSARCH.COM

JOB NO:22-002
DWG ISSUED ON:
09/27/2022
DWG SCALE:
1/8" = 1'-0"
DWG NUMBER:
PPR-133

9/27/2022 8:19:04 AM

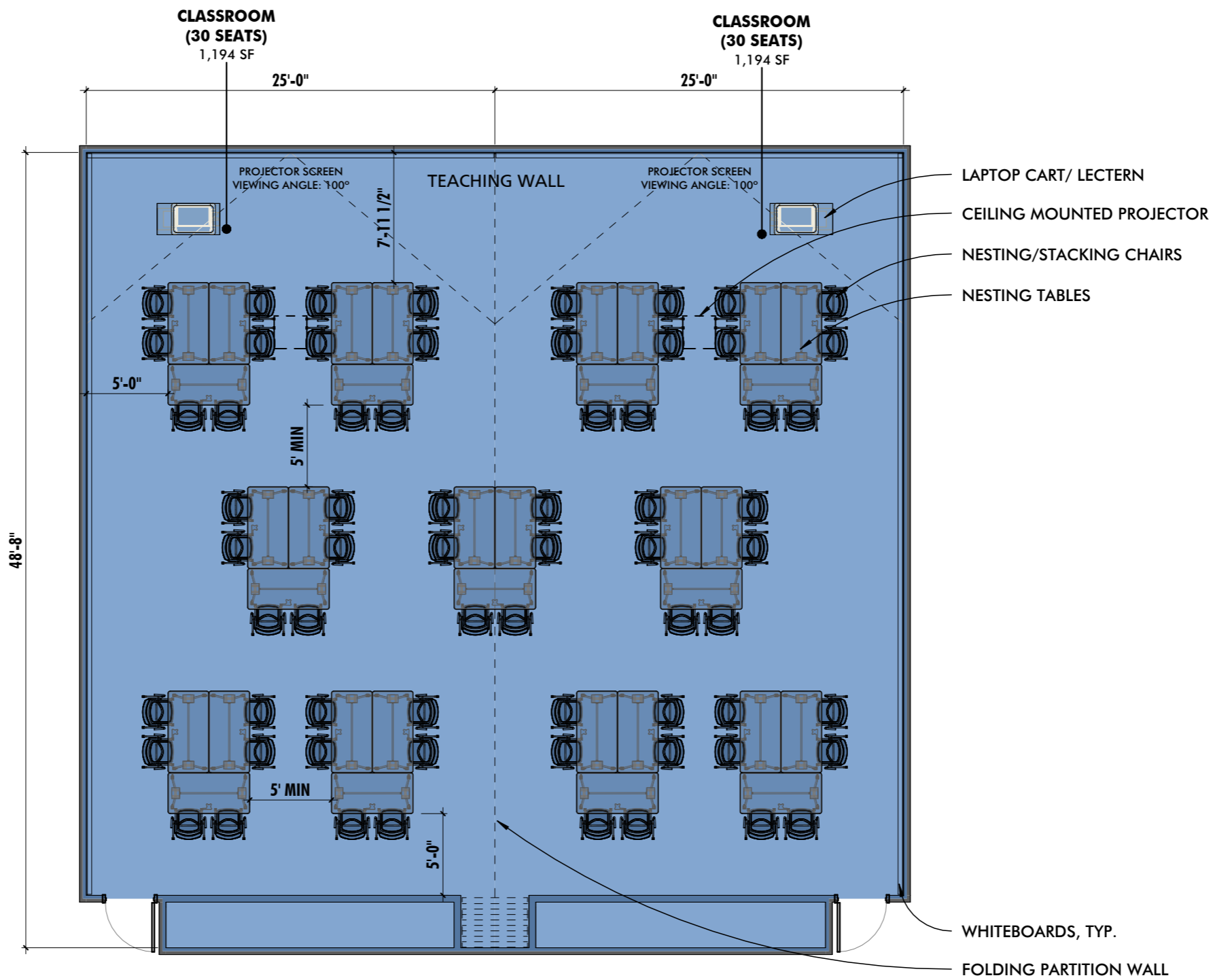

FLEX CLASSROOM (30/66 PERSON) - FIRING RANGE
BALTIMORE POLICE DEPARTMENT
COPPIN STATE PUBLIC SAFETY BUILDING



10839-D PHILADELPHIA RD
 WHITE MARSH, MD 21162
 410-344-1460
 INFO@MWSARCH.COM
 WWW.MWSARCH.COM

JOB NO:22-002

DWG ISSUED ON:
09/27/2022

DWG SCALE:
1/8" = 1'-0"

DWG NUMBER:
PPR-134

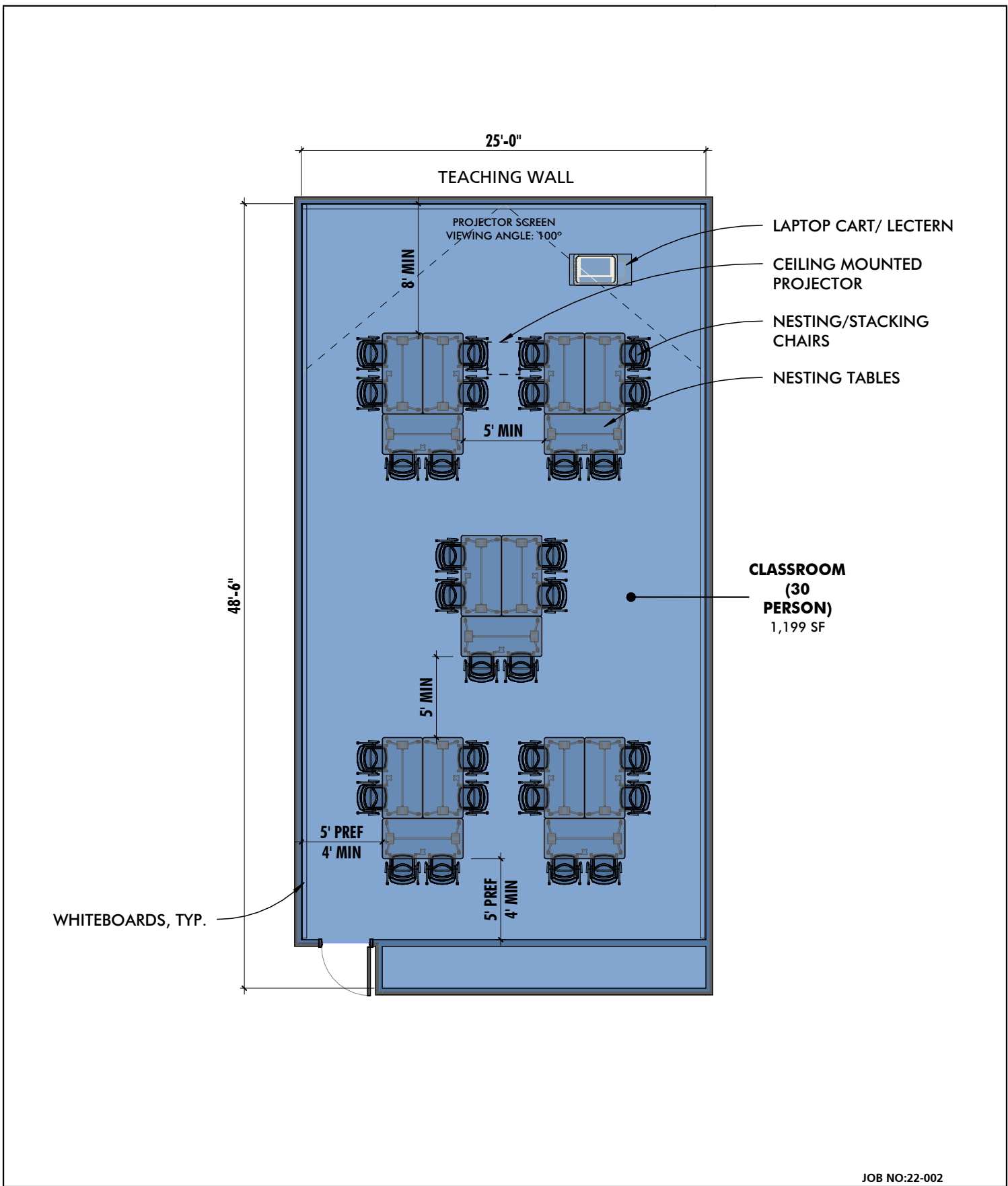

CLASSROOM (30 PERSON) - FIRING RANGE

BALTIMORE POLICE DEPARTMENT

COPPIN STATE PUBLIC SAFETY BUILDING

MANN
STUDIOS
ARCHITECTURE + MASTER PLANNING

10839-D PHILADELPHIA RD
WHITE MARSH, MD 21162

410-344-1460
INFO@MWSARCH.COM
WWW.MWSARCH.COM

JOB NO:22-002

DWG ISSUED ON:
09/27/2022

DWG SCALE:
1/8" = 1'-0"

DWG NUMBER:
PPR-135

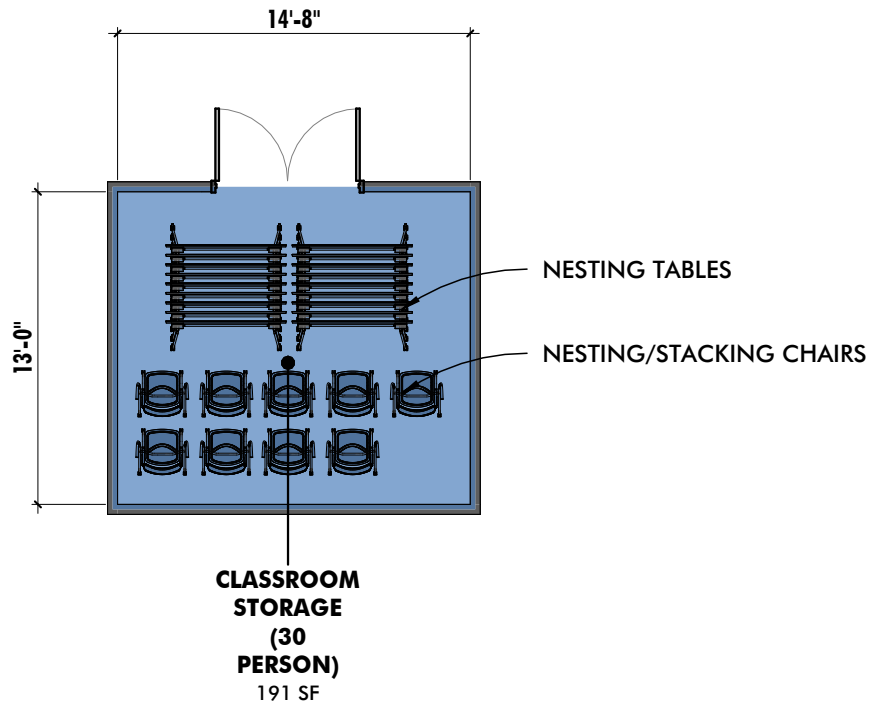

CLASSROOM STORAGE - FIRING RANGE
BALTIMORE POLICE DEPARTMENT
COPPIN STATE PUBLIC SAFETY BUILDING



10839-D PHILADELPHIA RD
 WHITE MARSH, MD 21162
 410-344-1460
 INFO@MWSARCH.COM
 WWW.MWSARCH.COM

JOB NO:22-002
DWG ISSUED ON:
09/27/2022
DWG SCALE:
1/8" = 1'-0"
DWG NUMBER:
PPR-136

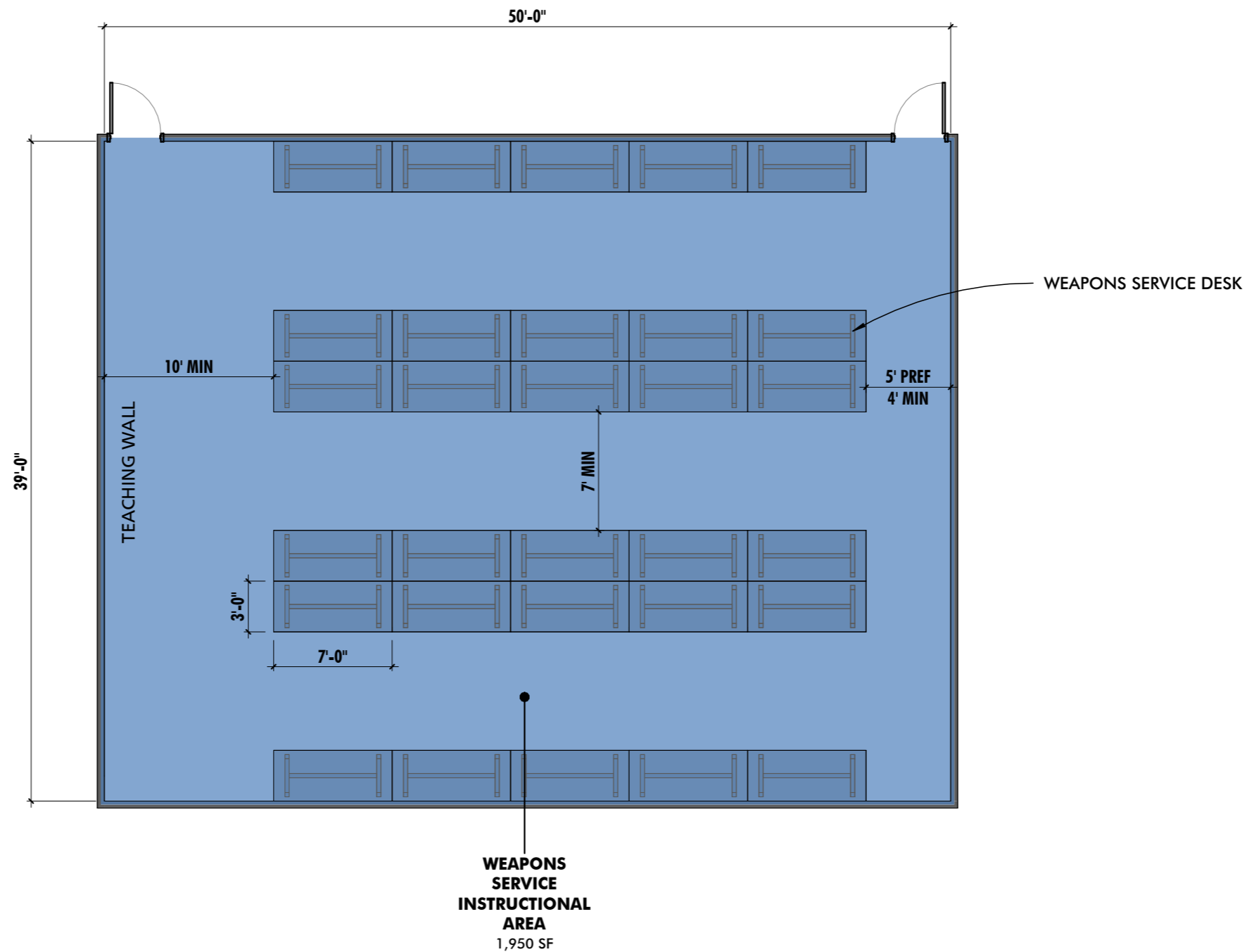

WEAPONS SERVICE INSTRUCTIONAL AREA - FIRING RANGE

**BALTIMORE POLICE DEPARTMENT
COPPIN STATE PUBLIC SAFETY BUILDING**



10839-D PHILADELPHIA RD
WHITE MARSH, MD 21162
410-344-1460
INFO@MWSARCH.COM
WWW.MWSARCH.COM

JOB NO:22-002

DWG ISSUED ON:
09/27/2022

DWG SCALE:
1/8" = 1'-0"

DWG NUMBER:
PPR-137

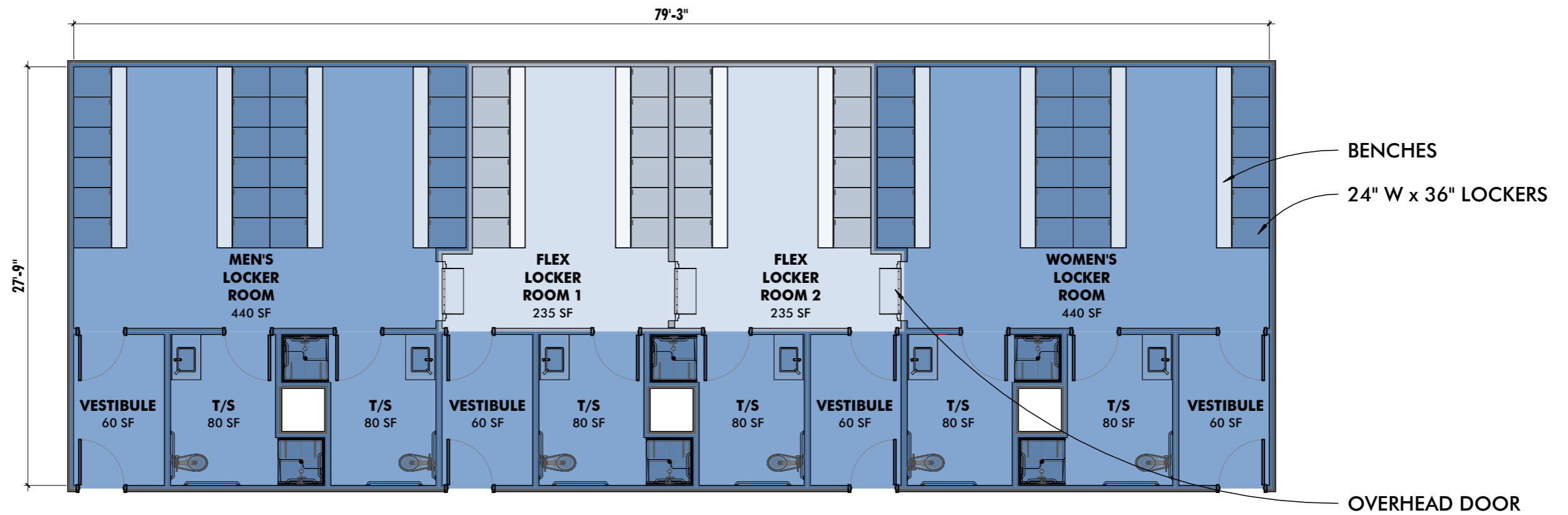

INSTRUCTOR LOCKERS - FIRING RANGE
BALTIMORE POLICE DEPARTMENT
COPPIN STATE PUBLIC SAFETY BUILDING



10839-D PHILADELPHIA RD
 WHITE MARSH, MD 21162
 410-344-1460
 INFO@MWSARCH.COM
 WWW.MWSARCH.COM

JOB NO:22-002

DWG ISSUED ON:
09/27/2022

DWG SCALE:
1/8" = 1'-0"

DWG NUMBER:
PPR-148

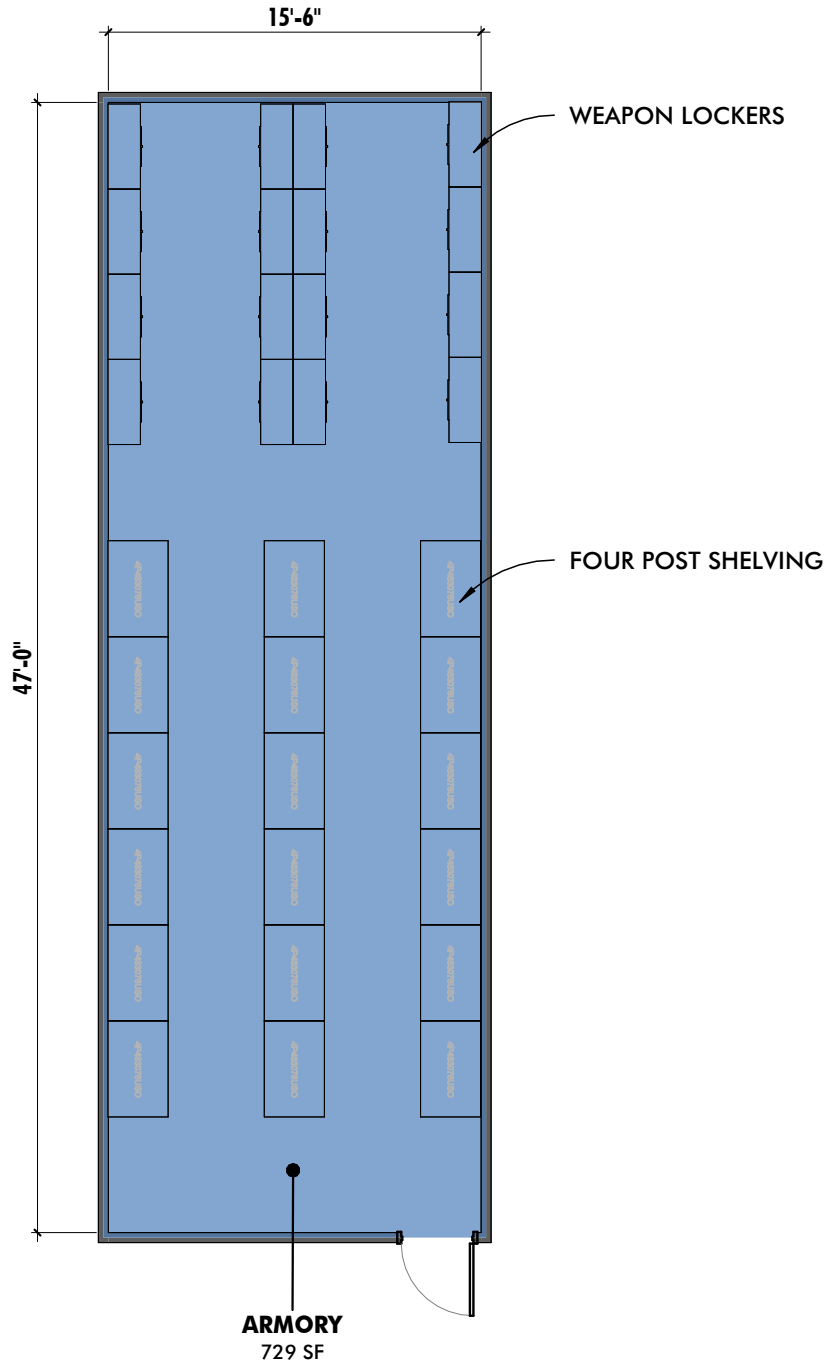

ARMORY
BALTIMORE POLICE DEPARTMENT
COPPIN STATE PUBLIC SAFETY BUILDING



10839-D PHILADELPHIA RD
 WHITE MARSH, MD 21162
 410-344-1460
 INFO@MWSARCH.COM
 WWW.MWSARCH.COM

JOB NO:22-002
 DWG ISSUED ON:
09/27/2022
 DWG SCALE:
1/8" = 1'-0"
 DWG NUMBER:
PPR-149

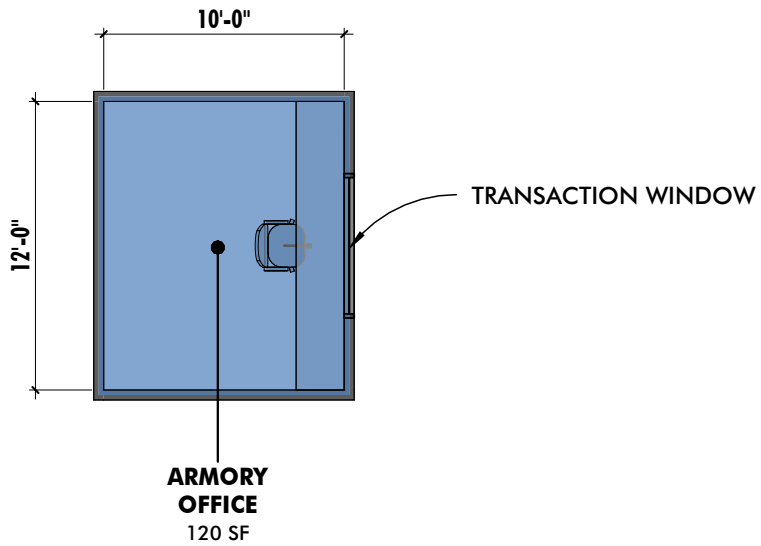

ARMORY OFFICE
BALTIMORE POLICE DEPARTMENT
COPPIN STATE PUBLIC SAFETY BUILDING



10839-D PHILADELPHIA RD
 WHITE MARSH, MD 21162
 410-344-1460
 INFO@MWSARCH.COM
 WWW.MWSARCH.COM

JOB NO:22-002
DWG ISSUED ON:
09/27/2022
DWG SCALE:
1/8" = 1'-0"
DWG NUMBER:
PPR-150

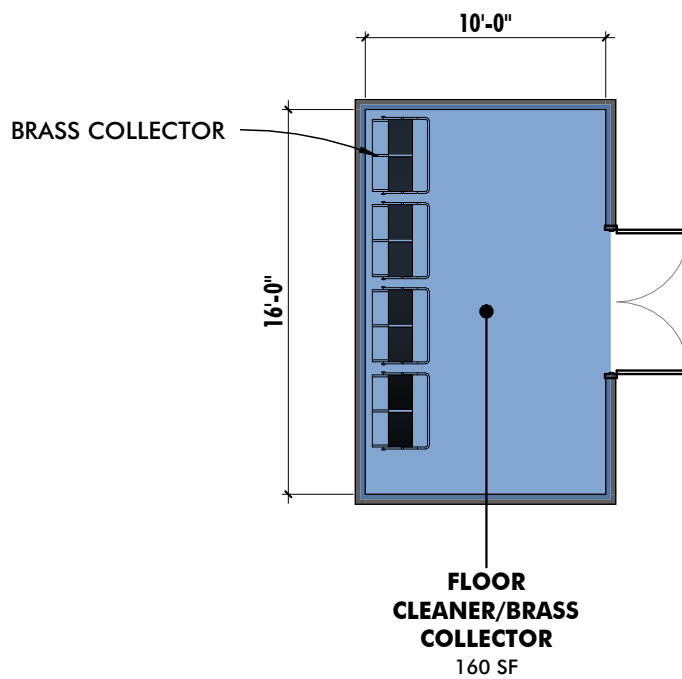

FLOOR CLEANER/BRASS COLLECTOR STORAGE
BALTIMORE POLICE DEPARTMENT
COPPIN STATE PUBLIC SAFETY BUILDING



10839-D PHILADELPHIA RD
 WHITE MARSH, MD 21162
 410-344-1460
 INFO@MWSARCH.COM
 WWW.MWSARCH.COM

JOB NO:22-002
DWG ISSUED ON:
09/27/2022
DWG SCALE:
1/8" = 1'-0"
DWG NUMBER:
PPR-151

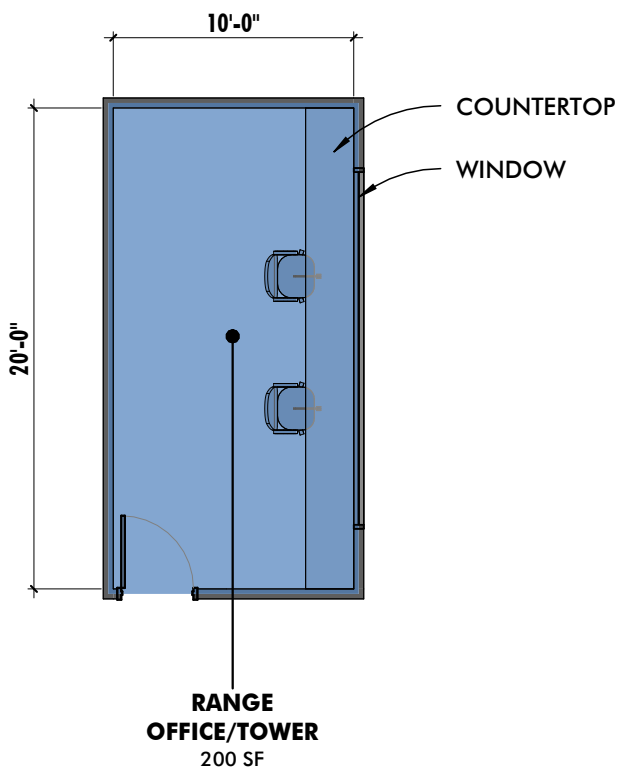

RANGE CONTROL OFFICE
BALTIMORE POLICE DEPARTMENT
COPPIN STATE PUBLIC SAFETY BUILDING



10839-D PHILADELPHIA RD
 WHITE MARSH, MD 21162
 410-344-1460
 INFO@MWSARCH.COM
 WWW.MWSARCH.COM

JOB NO:22-002

DWG ISSUED ON:
09/27/2022

DWG SCALE:
1/8" = 1'-0"

DWG NUMBER:
PPR-162

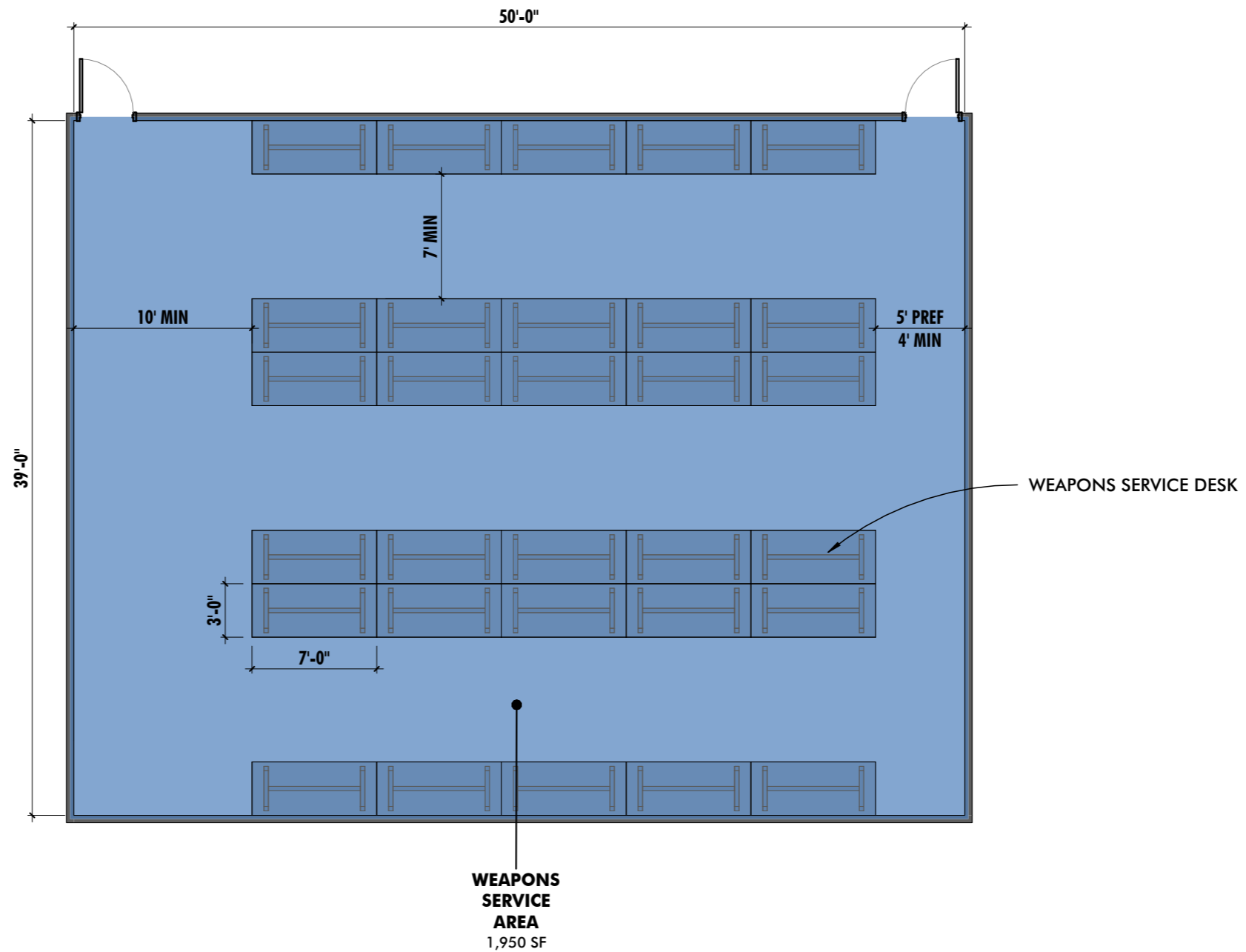

WEAPONS SERVICE AREA
BALTIMORE POLICE DEPARTMENT
COPPIN STATE PUBLIC SAFETY BUILDING



10839-D PHILADELPHIA RD
 WHITE MARSH, MD 21162
 410-344-1460
 INFO@MWSARCH.COM
 WWW.MWSARCH.COM

JOB NO:22-002

DWG ISSUED ON:
09/27/2022

DWG SCALE:
 1/8" = 1'-0"

DWG NUMBER:
PPR-163

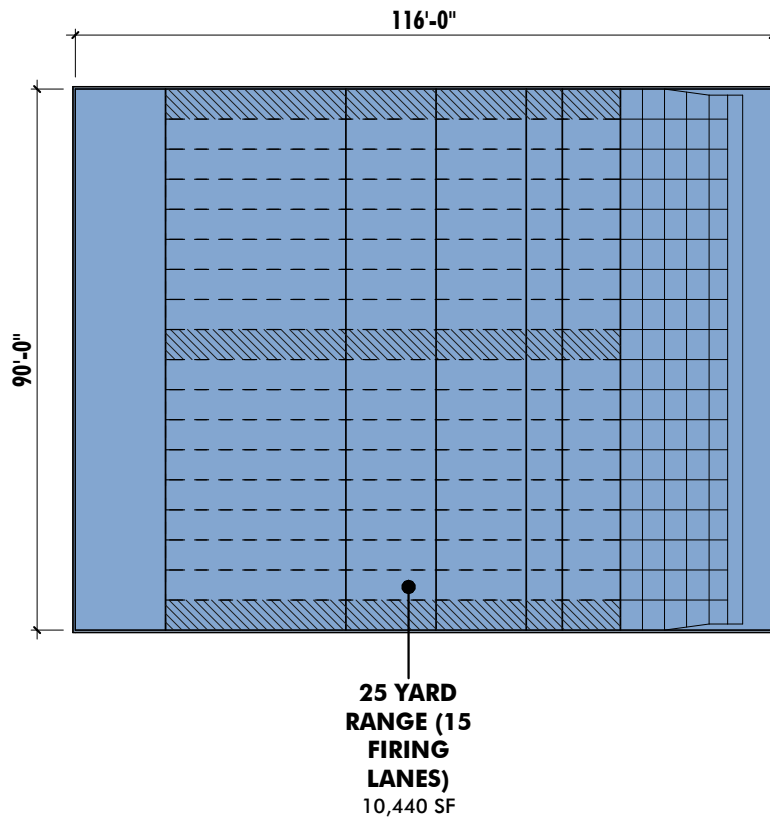

25 YARD RANGE (15 FIRING LANES)
BALTIMORE POLICE DEPARTMENT
COPPIN STATE PUBLIC SAFETY BUILDING



10839-D PHILADELPHIA RD
 WHITE MARSH, MD 21162
 410-344-1460
 INFO@MWSARCH.COM
 WWW.MWSARCH.COM

JOB NO:22-002
 DWG ISSUED ON:
09/27/2022
 DWG SCALE:
1/32" = 1'-0"
 DWG NUMBER:
PPR-164

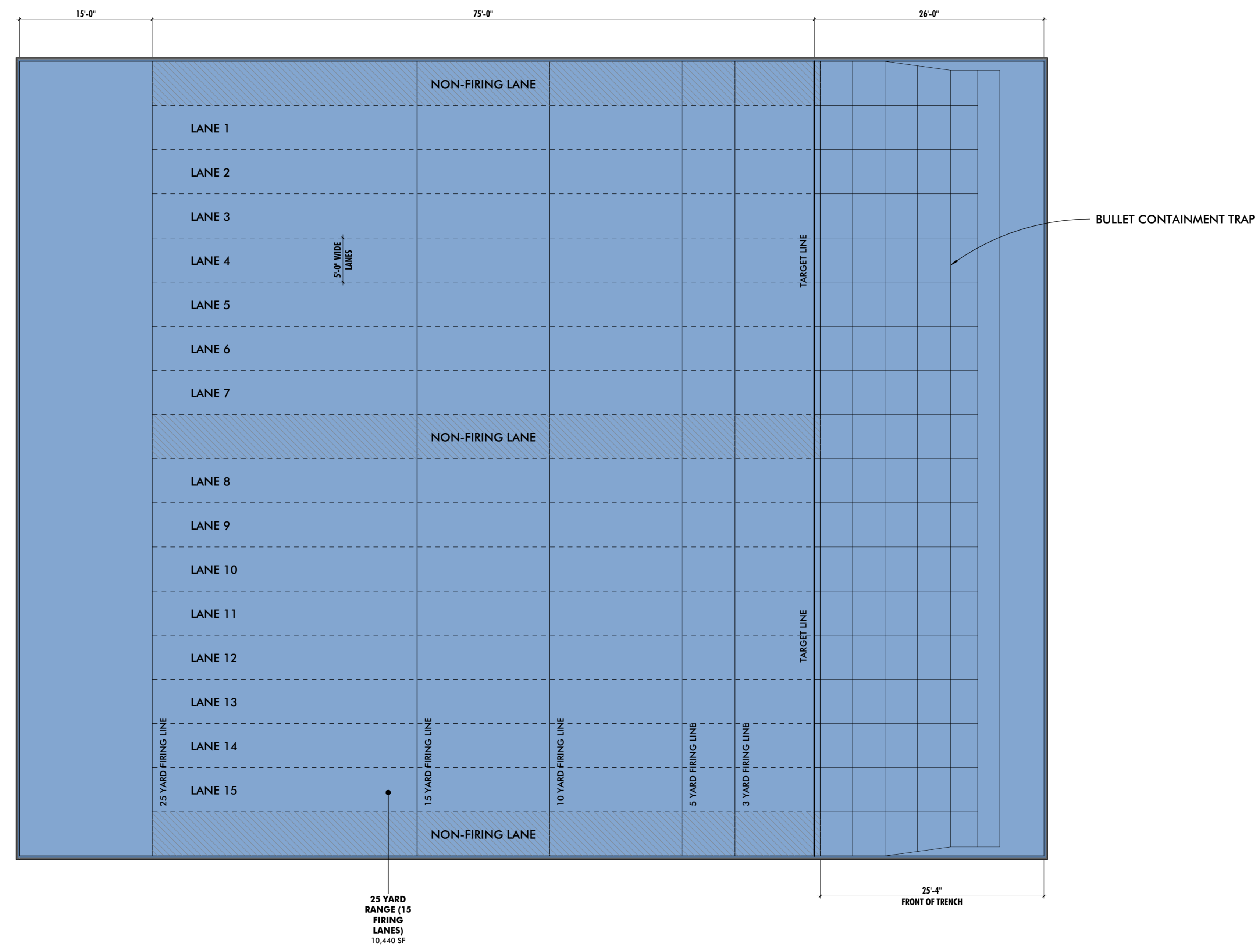

25 YARD RANGE

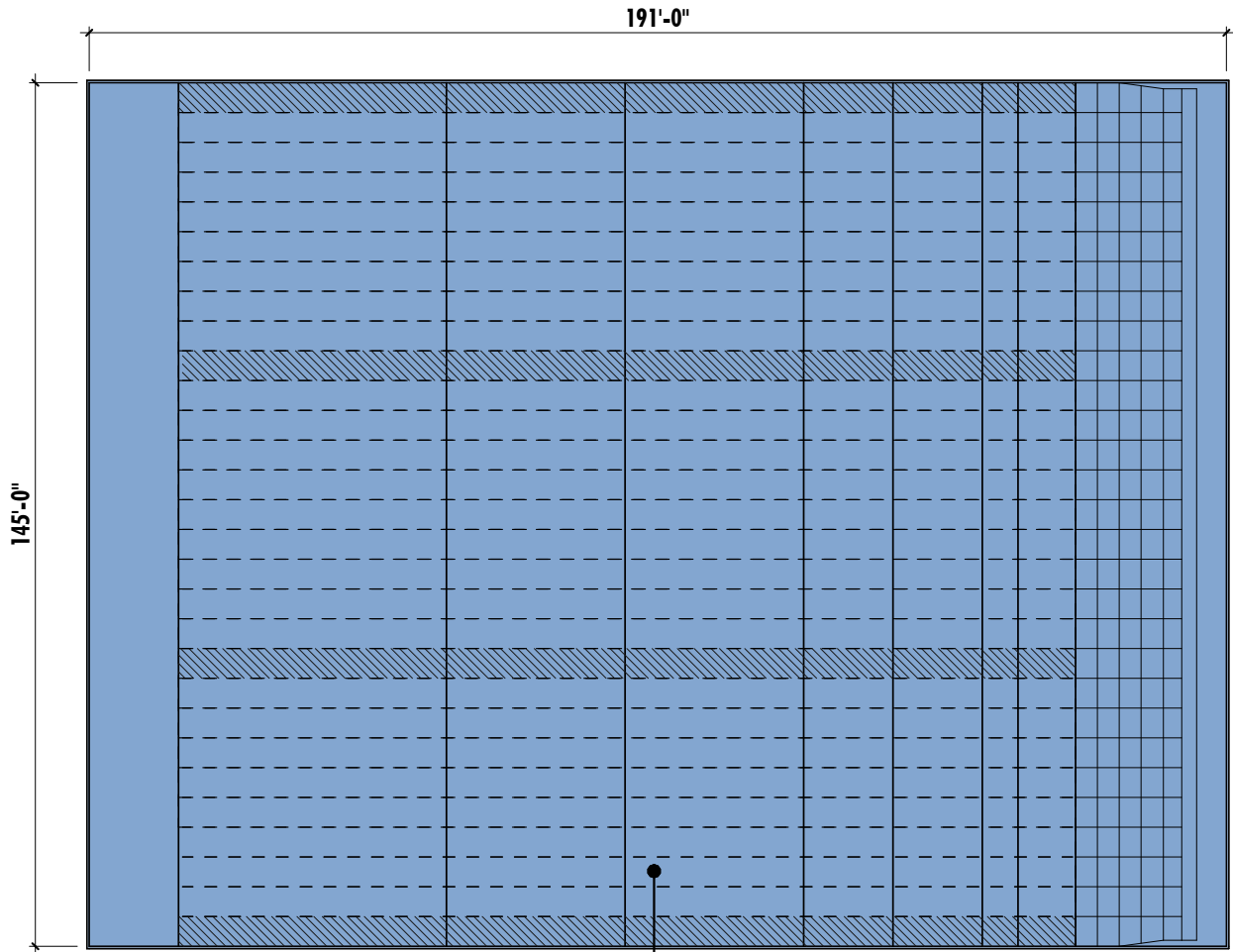

**50 YARD
RANGE (25
FIRING
LANES)**
27,695 SF

50 YARD RANGE (25 FIRING LANES)
BALTIMORE POLICE DEPARTMENT
COPPIN STATE PUBLIC SAFETY BUILDING



10839-D PHILADELPHIA RD
WHITE MARSH, MD 21162
410-344-1460
INFO@MWSARCH.COM
WWW.MWSARCH.COM

JOB NO:22-002

DWG ISSUED ON:
09/27/2022

DWG SCALE:
1/32" = 1'-0"

DWG NUMBER:
PPR-165

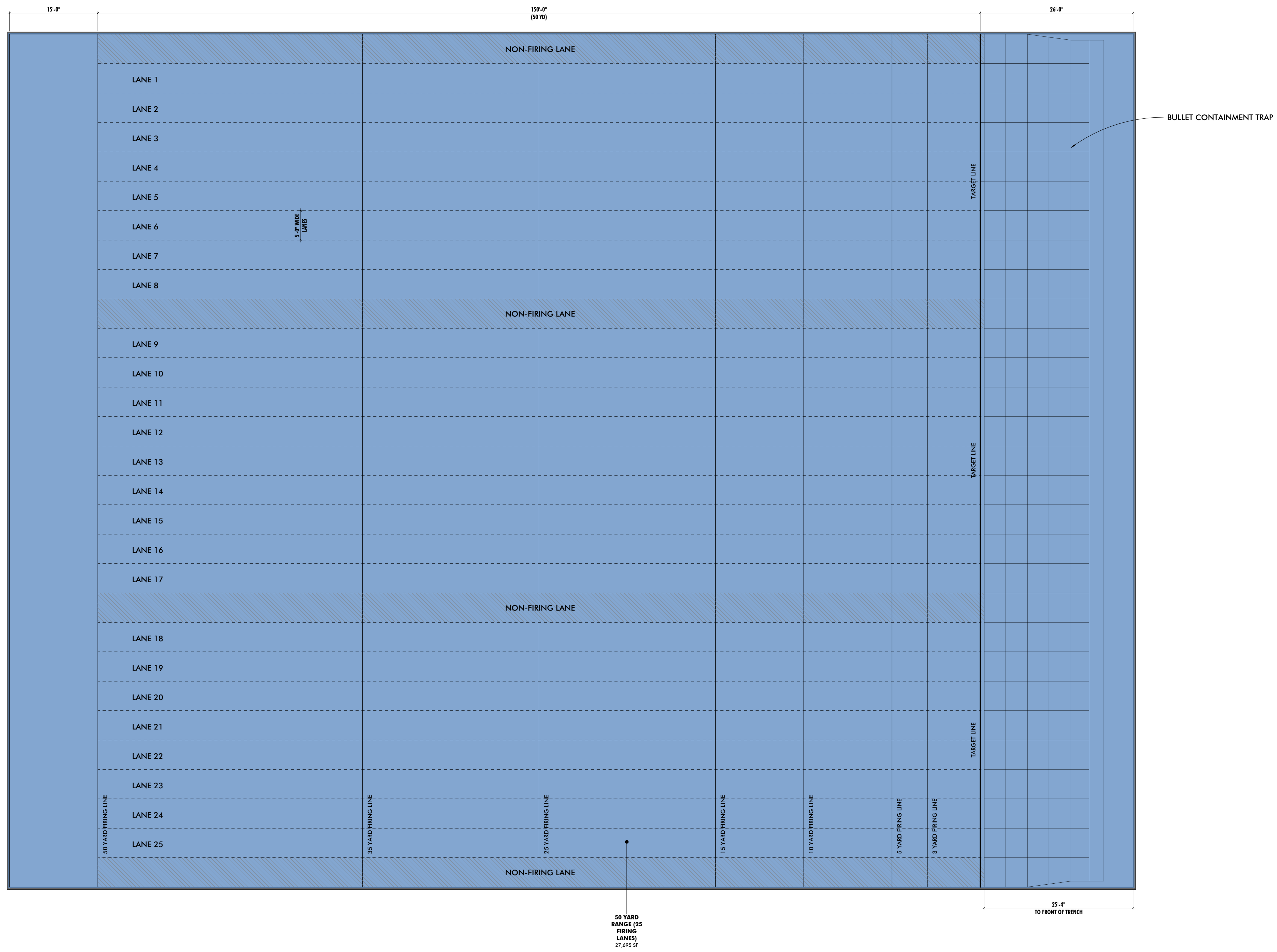

50 YARD RANGE

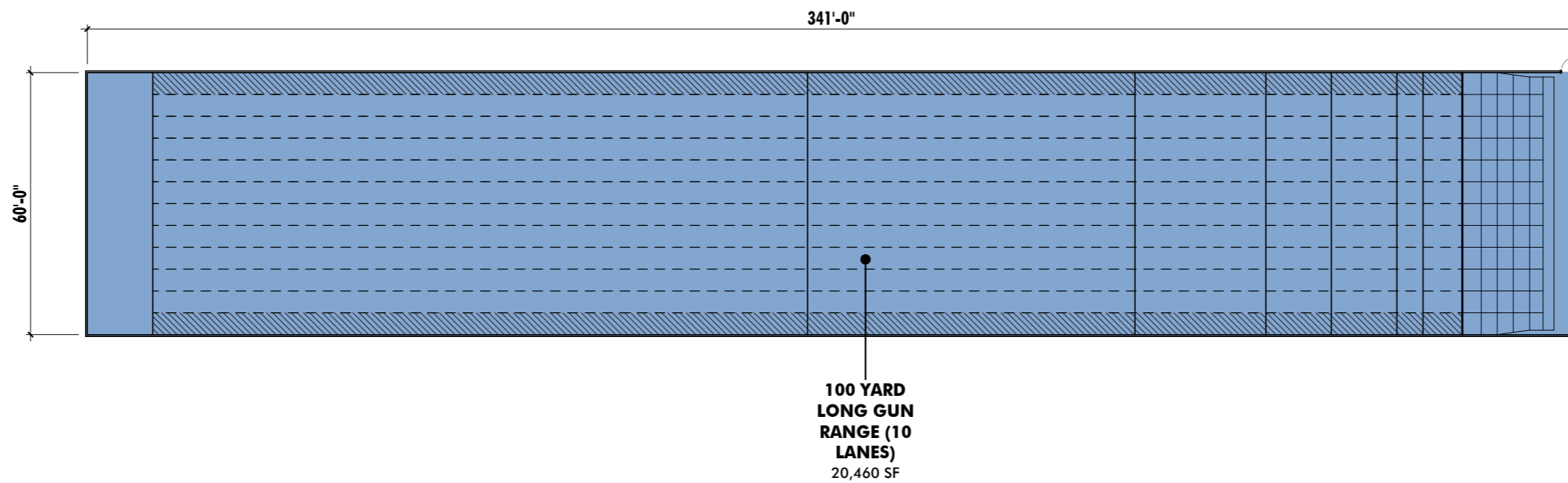

100 YARD LONG GUN RANGE (10 FIRING LANES)
BALTIMORE POLICE DEPARTMENT
COPPIN STATE PUBLIC SAFETY BUILDING



10839-D PHILADELPHIA RD
 WHITE MARSH, MD 21162
 410-344-1460
 INFO@MWSARCH.COM
 WWW.MWSARCH.COM

JOB NO:22-002

DWG ISSUED ON:
09/27/2022

DWG SCALE:
1/32" = 1'-0"

DWG NUMBER:
PPR-166

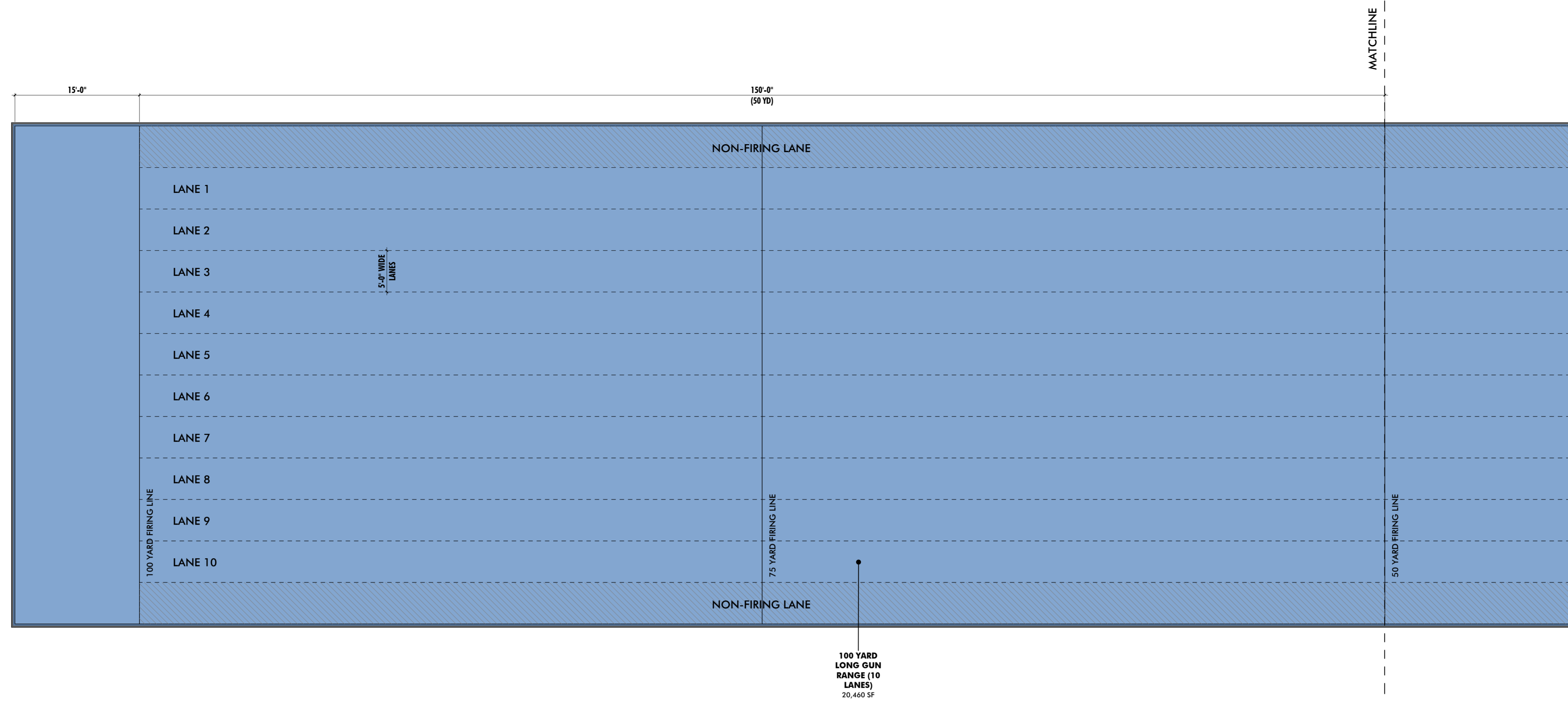

PPR-166A - POLICE - 100 YARD RANGE - AREA A

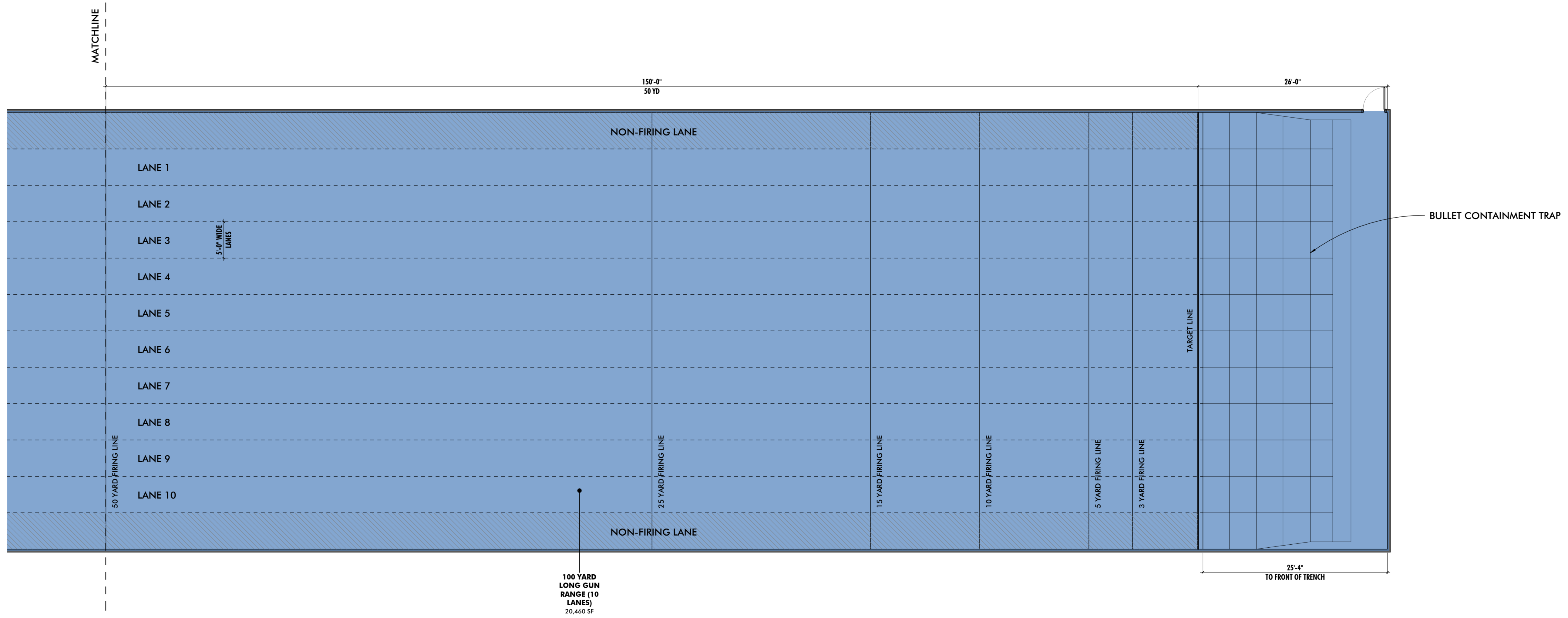

② 100 YARD RANGE - AREA B
1/8" = 1'-0"

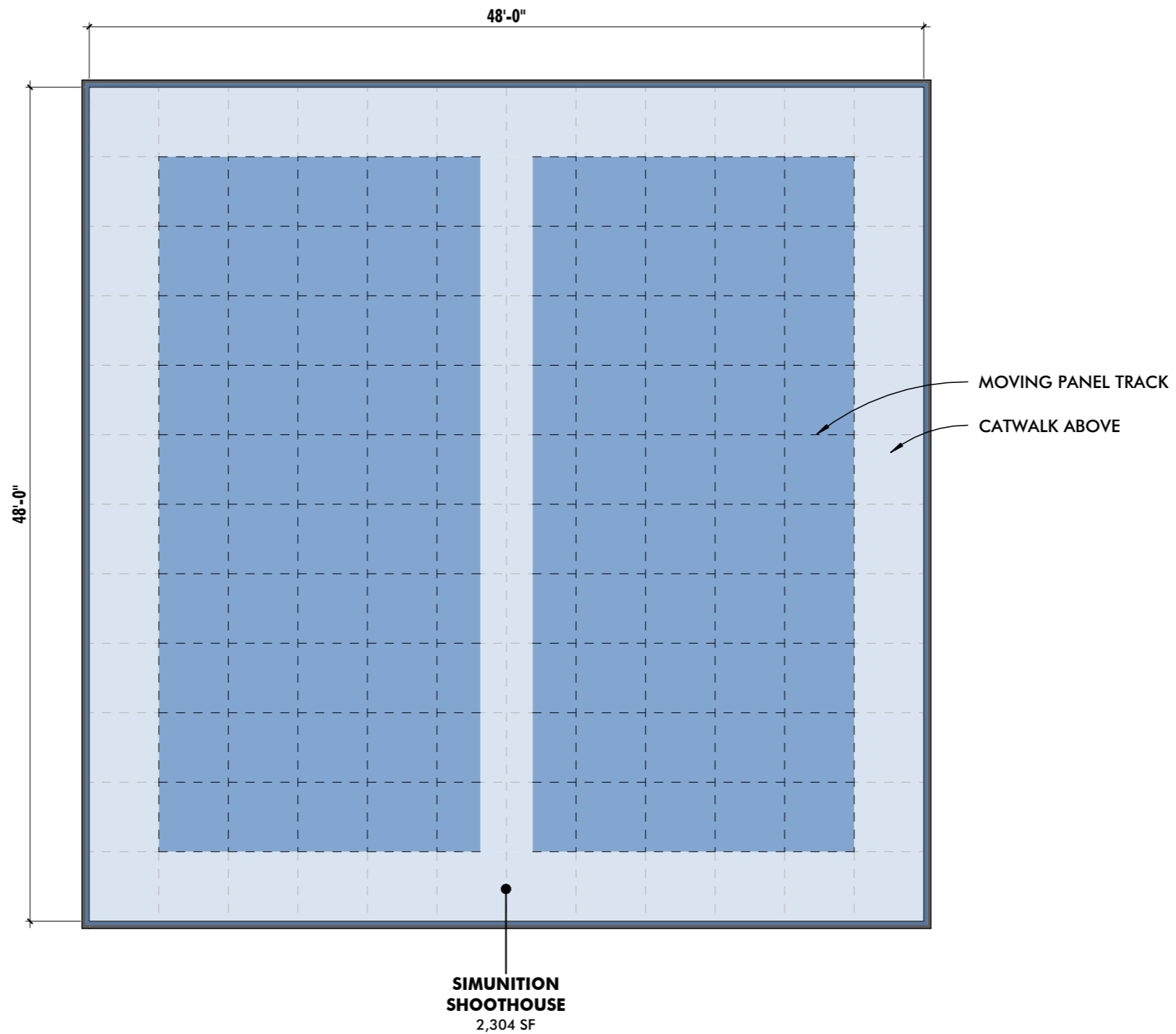

SIMUNITION SHOOTHOUSE
BALTIMORE POLICE DEPARTMENT
COPPIN STATE PUBLIC SAFETY BUILDING



10839-D PHILADELPHIA RD
 WHITE MARSH, MD 21162
 410-344-1460
 INFO@MWSARCH.COM
 WWW.MWSARCH.COM

JOB NO:22-002

DWG ISSUED ON:
09/27/2022

DWG SCALE:
1/8" = 1'-0"

DWG NUMBER:
PPR-177

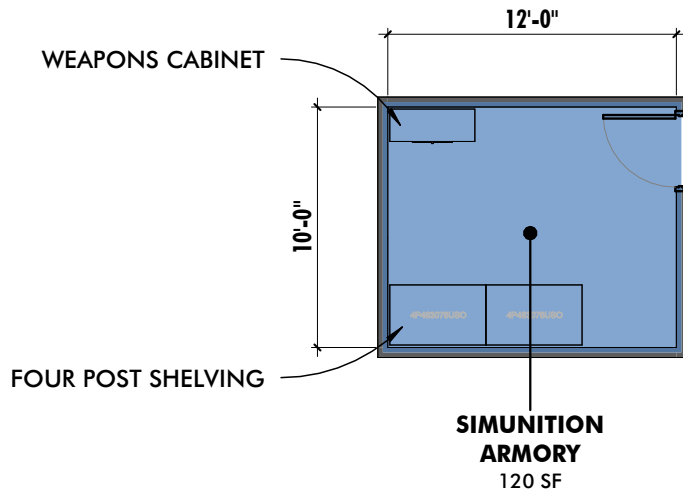

SIMUNITION ARMORY
BALTIMORE POLICE DEPARTMENT
COPPIN STATE PUBLIC SAFETY BUILDING



10839-D PHILADELPHIA RD
 WHITE MARSH, MD 21162
 410-344-1460
 INFO@MWSARCH.COM
 WWW.MWSARCH.COM

JOB NO:22-002
DWG ISSUED ON:
09/27/2022
DWG SCALE:
1/8" = 1'-0"
DWG NUMBER:
PPR-178

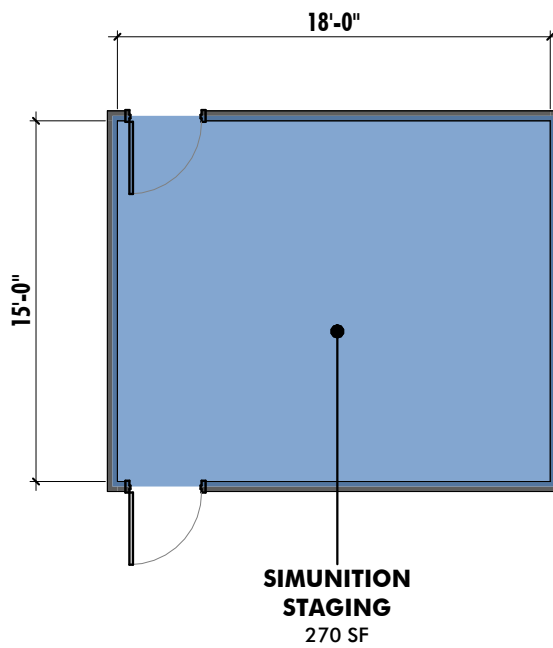

SIMUNITION STAGING
BALTIMORE POLICE DEPARTMENT
COPPIN STATE PUBLIC SAFETY BUILDING



10839-D PHILADELPHIA RD
WHITE MARSH, MD 21162
410-344-1460
INFO@MWSARCH.COM
WWW.MWSARCH.COM

JOB NO:22-002
DWG ISSUED ON:
09/27/2022
DWG SCALE:
1/8" = 1'-0"
DWG NUMBER:
PPR-179

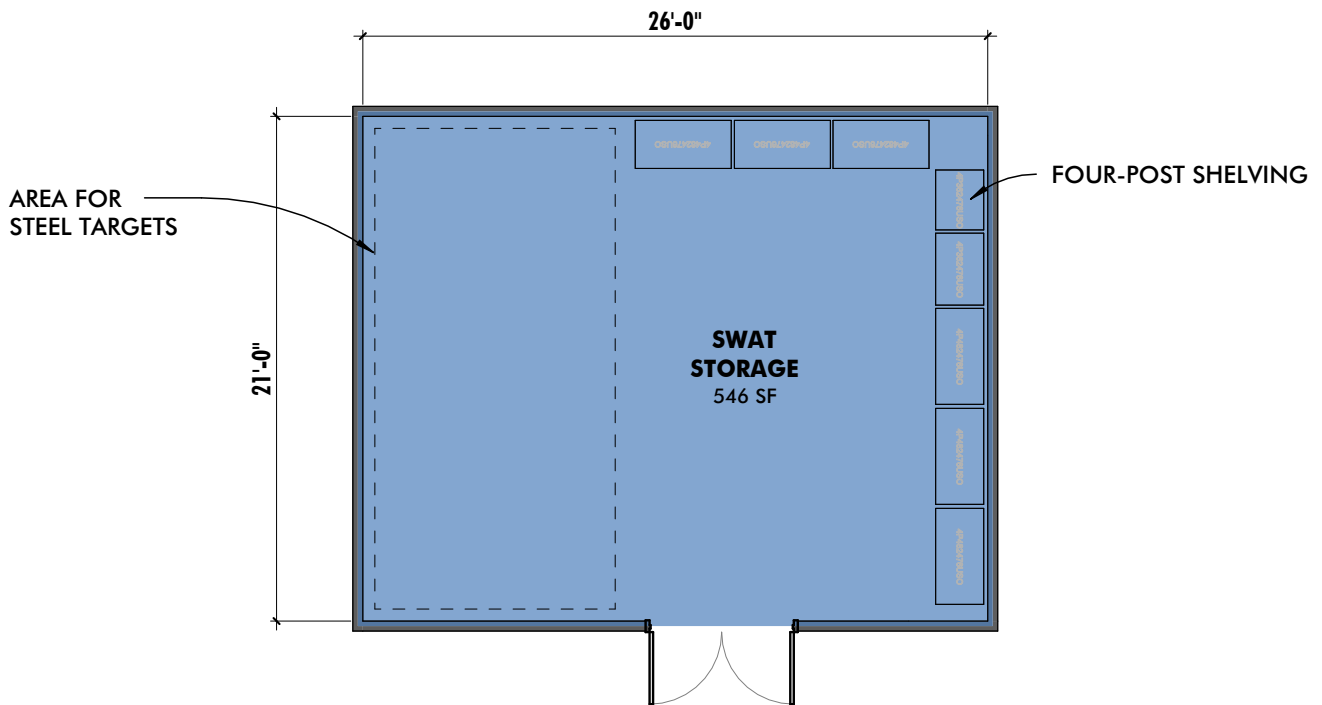

SWAT STORAGE
BALTIMORE POLICE DEPARTMENT
COPPIN STATE PUBLIC SAFETY BUILDING



10839-D PHILADELPHIA RD
 WHITE MARSH, MD 21162
 410-344-1460
 INFO@MWSARCH.COM
 WWW.MWSARCH.COM

JOB NO:22-002

DWG ISSUED ON:
09/27/2022

DWG SCALE:
1/8" = 1'-0"

DWG NUMBER:
PPR-180

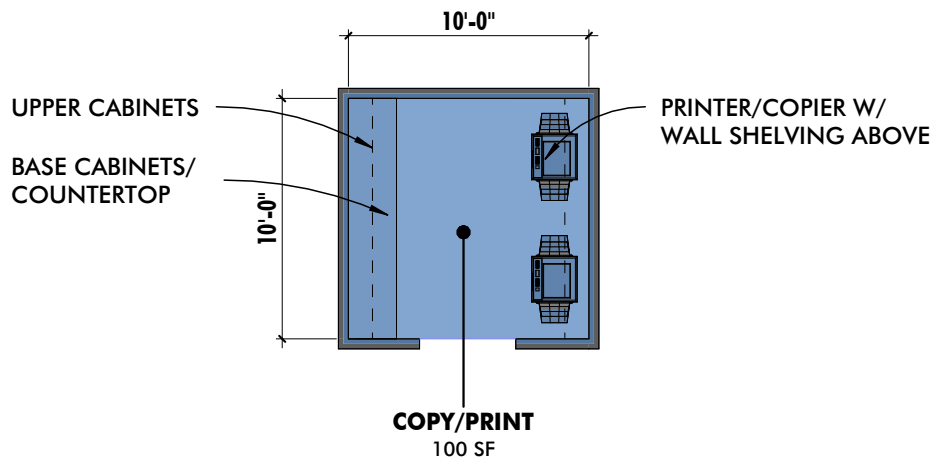

COPY/PRINT
BALTIMORE POLICE DEPARTMENT
COPPIN STATE PUBLIC SAFETY BUILDING



10839-D PHILADELPHIA RD
 WHITE MARSH, MD 21162
 410-344-1460
 INFO@MWSARCH.COM
 WWW.MWSARCH.COM

JOB NO:22-002
DWG ISSUED ON:
09/27/2022
DWG SCALE:
1/8" = 1'-0"
DWG NUMBER:
PPR-181

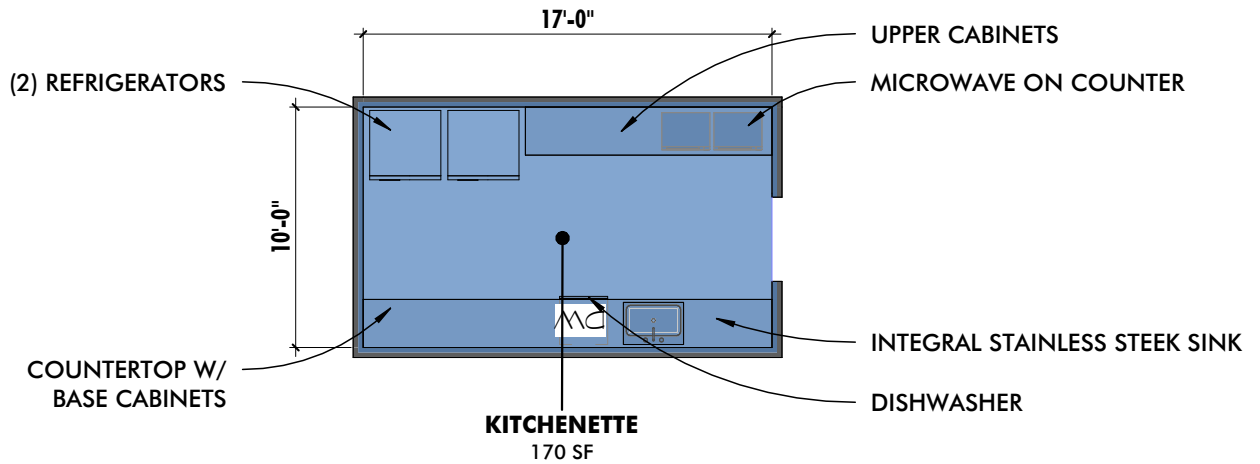

KITCHENETTE

BALTIMORE POLICE DEPARTMENT

COPPIN STATE PUBLIC SAFETY BUILDING



10839-D PHILADELPHIA RD
WHITE MARSH, MD 21162

410-344-1460
INFO@MWSARCH.COM
WWW.MWSARCH.COM

JOB NO:22-002

DWG ISSUED ON:
09/27/2022

DWG SCALE:
1/8" = 1'-0"

DWG NUMBER:
PPR-182

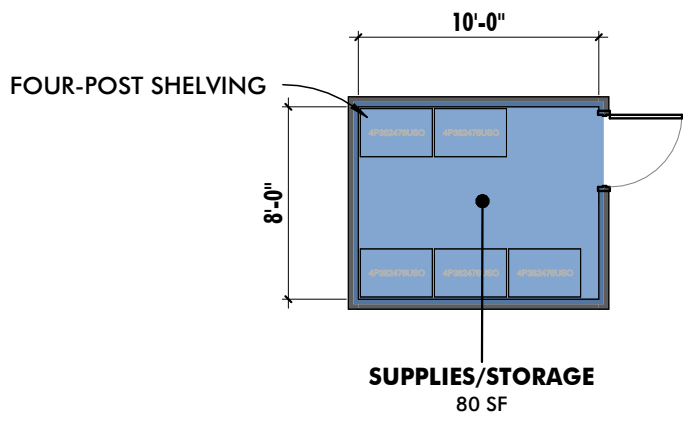

STORAGE - OFFICE SUPPLIES

BALTIMORE POLICE DEPARTMENT

COPPIN STATE PUBLIC SAFETY BUILDING



ARCHITECTURE + MASTER PLANNING

10839-D PHILADELPHIA RD
WHITE MARSH, MD 21162

410-344-1460
INFO@MWSARCH.COM
WWW.MWSARCH.COM

JOB NO:22-002

DWG ISSUED ON:
09/27/2022

DWG SCALE:
1/8" = 1'-0"

DWG NUMBER:
PPR-183

9/27/2022 8:23:07 AM

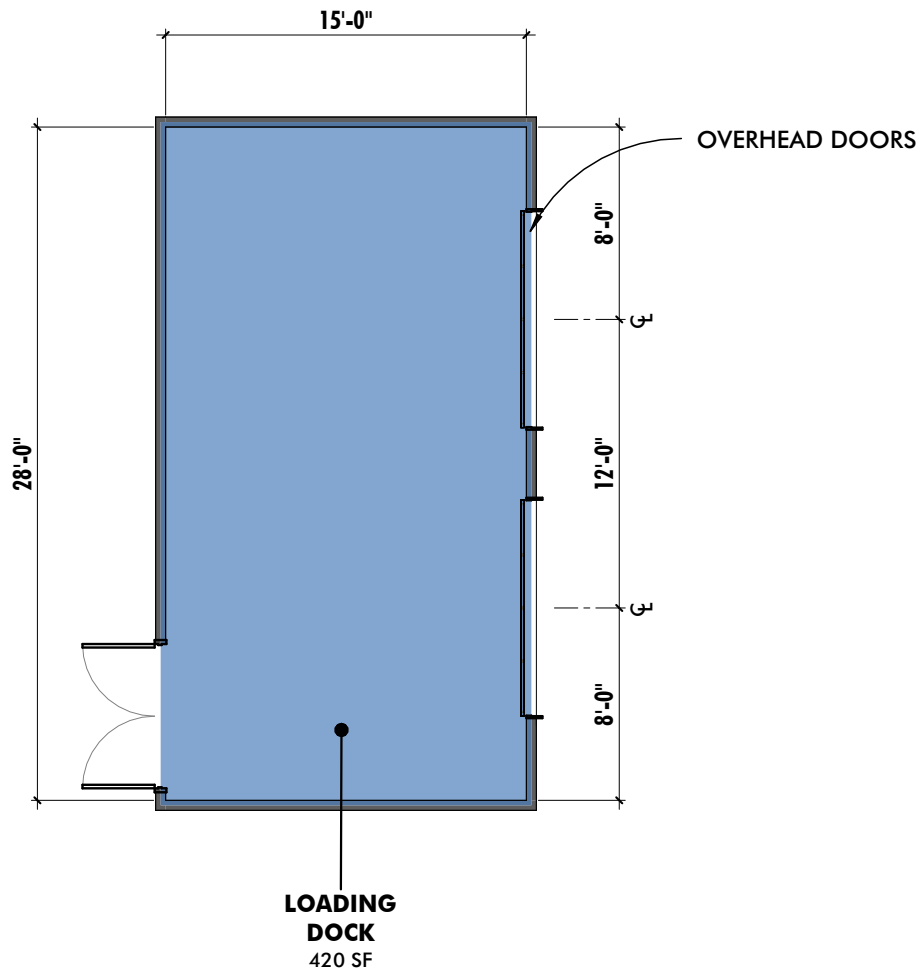

LOADING DOCK

BALTIMORE POLICE DEPARTMENT

COPPIN STATE PUBLIC SAFETY BUILDING



10839-D PHILADELPHIA RD
WHITE MARSH, MD 21162

410-344-1460
INFO@MWSARCH.COM
WWW.MWSARCH.COM

JOB NO:22-002

DWG ISSUED ON:
09/27/2022

DWG SCALE:
1/8" = 1'-0"

DWG NUMBER:
PPR-184

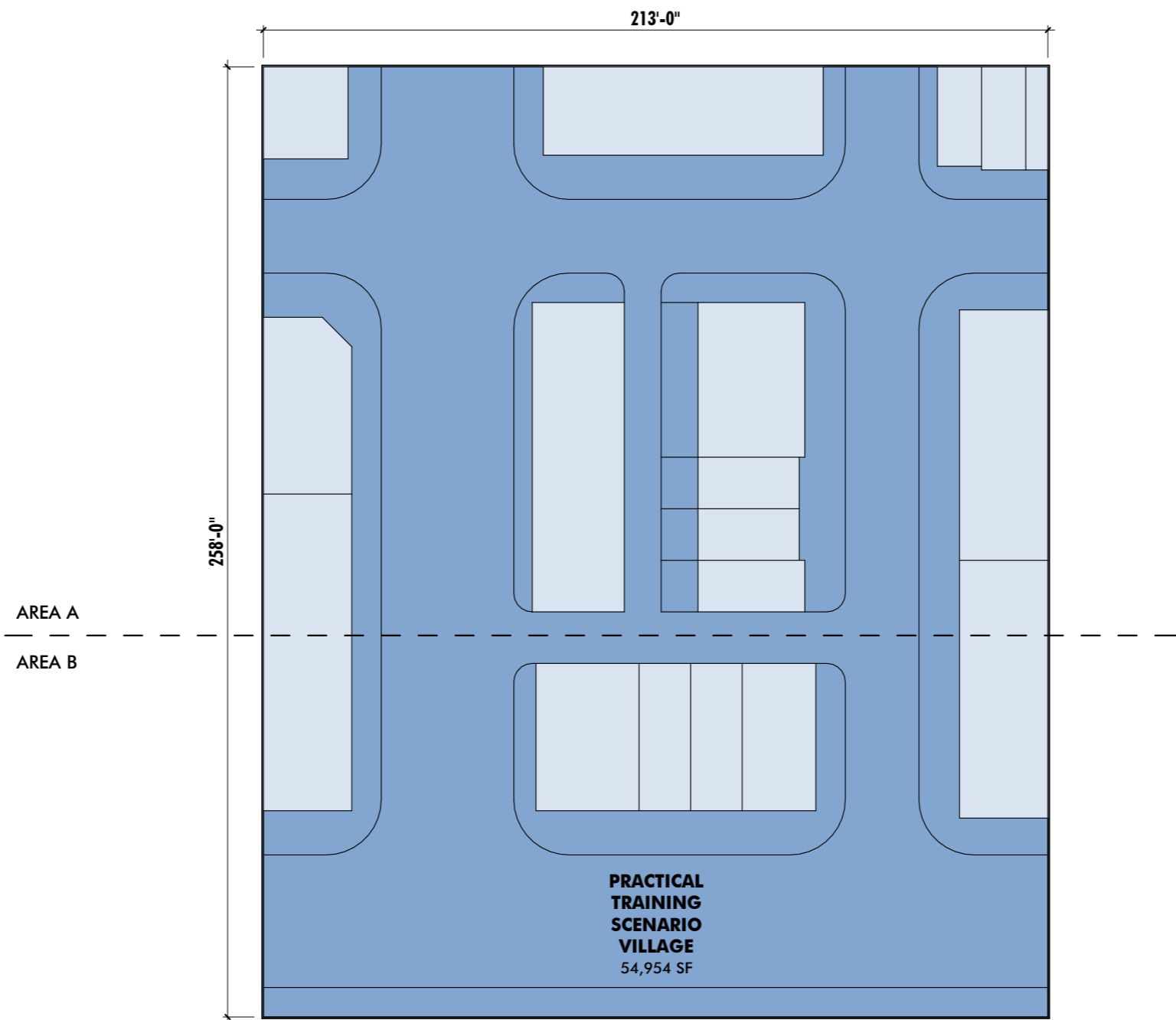

PRACTICAL TRAINING SCENARIO VILLAGE - OVERALL
BALTIMORE POLICE DEPARTMENT
COPPIN STATE PUBLIC SAFETY BUILDING



10839-D PHILADELPHIA RD
 WHITE MARSH, MD 21162
 410-344-1460
 INFO@MWSARCH.COM
 WWW.MWSARCH.COM

JOB NO:22-002

DWG ISSUED ON:
09/27/2022

DWG SCALE:
1" = 40'-0"

DWG NUMBER:
PPR-190

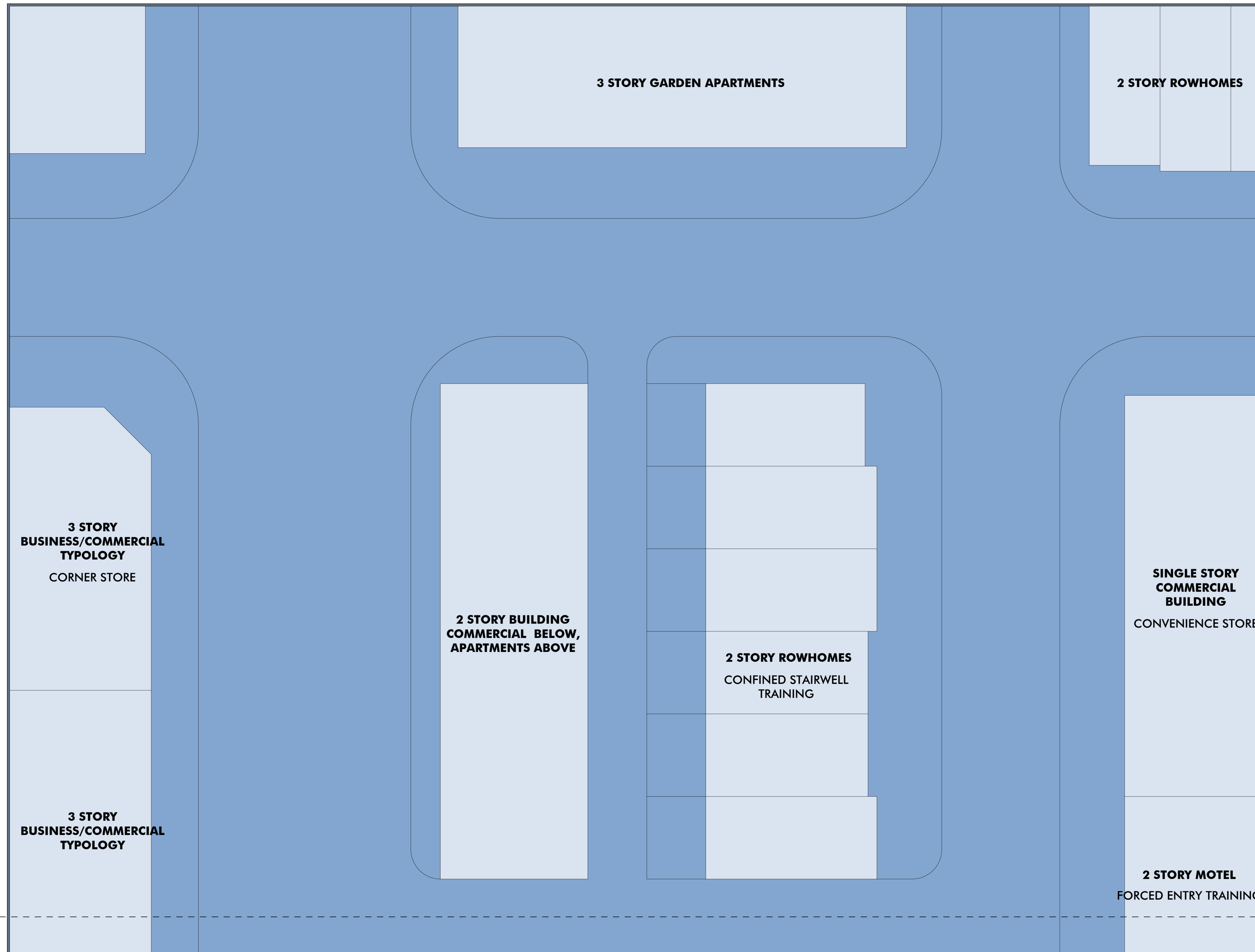

MATCHLINE

MATCHLINE

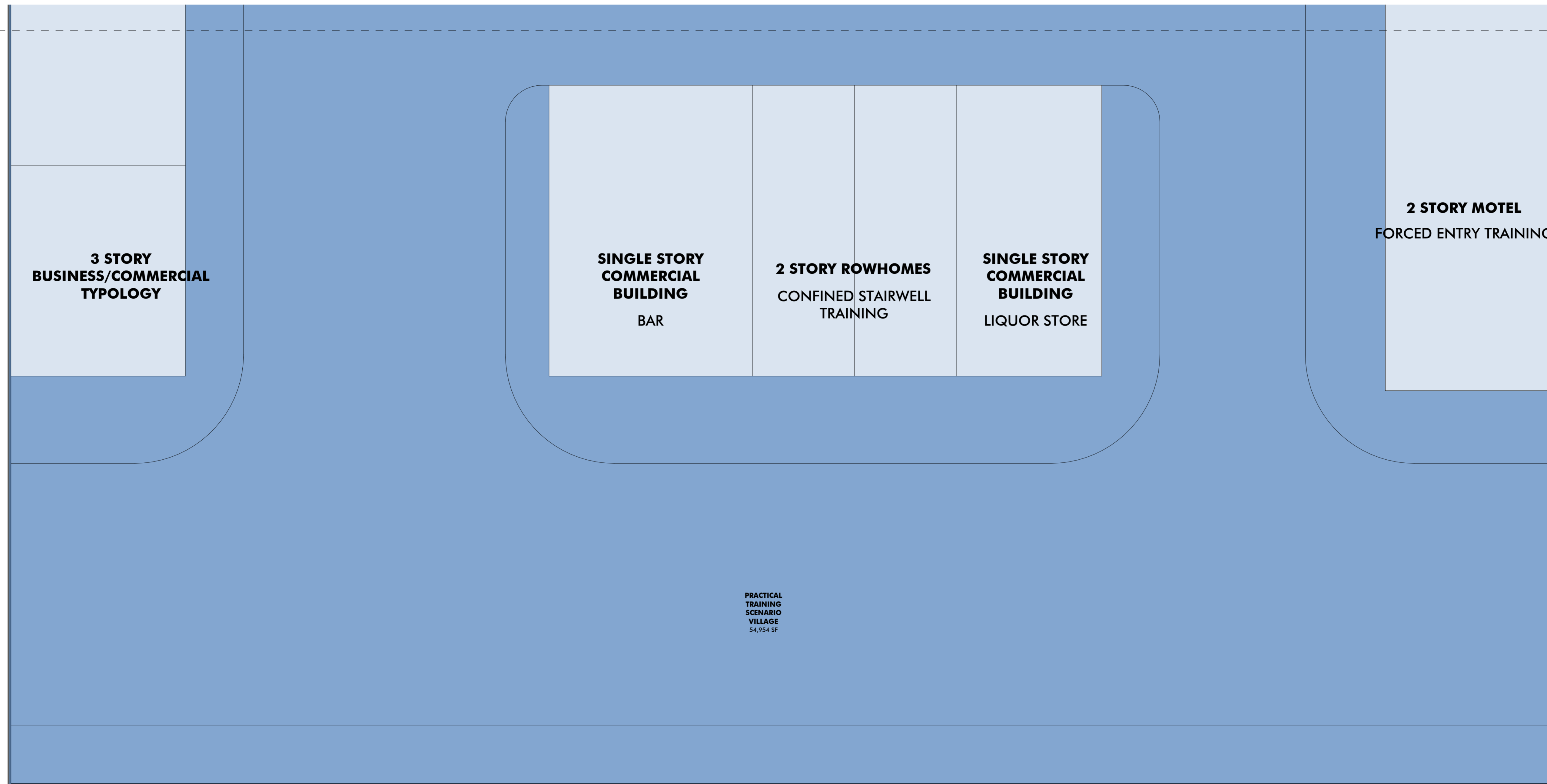

SIMULATION LABS

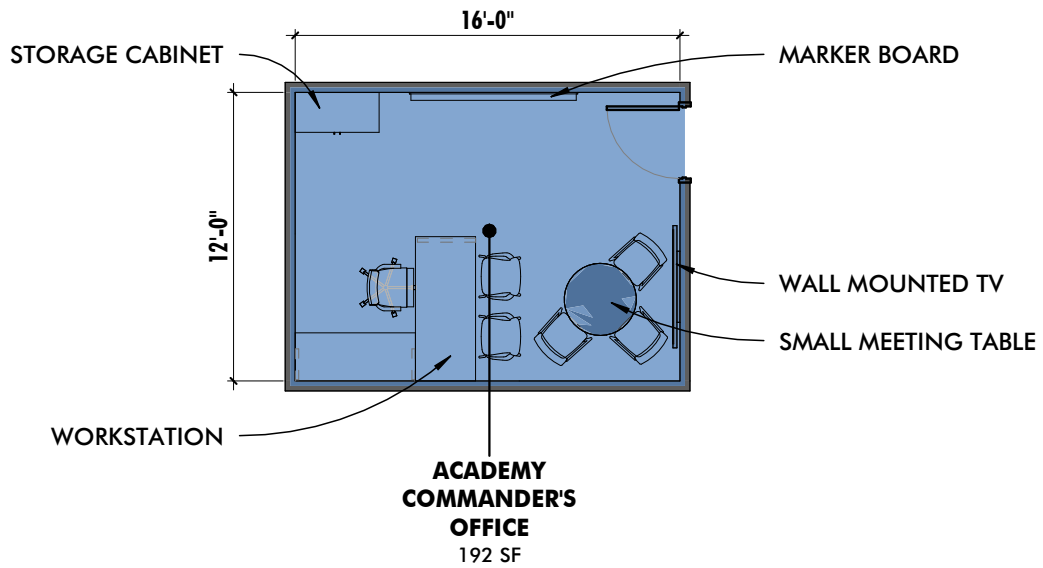

ACADEMY COMMANDER'S OFFICE
BALTIMORE POLICE DEPARTMENT
COPPIN STATE PUBLIC SAFETY BUILDING



10839-D PHILADELPHIA RD
 WHITE MARSH, MD 21162
 410-344-1460
 INFO@MWSARCH.COM
 WWW.MWSARCH.COM

JOB NO:22-002
DWG ISSUED ON:
09/27/2022
DWG SCALE:
1/8" = 1'-0"
DWG NUMBER:
PPR-196

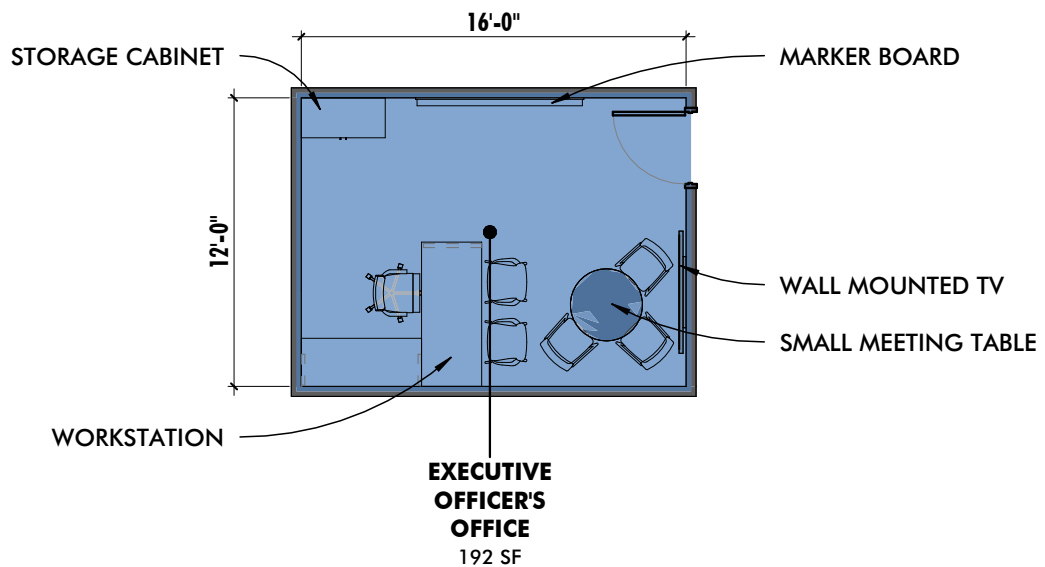

EXECUTIVE OFFICER'S OFFICE
BALTIMORE POLICE DEPARTMENT
COPPIN STATE PUBLIC SAFETY BUILDING



10839-D PHILADELPHIA RD
 WHITE MARSH, MD 21162
 410-344-1460
 INFO@MWSARCH.COM
 WWW.MWSARCH.COM

JOB NO:22-002
DWG ISSUED ON:
09/27/2022
DWG SCALE:
1/8" = 1'-0"
DWG NUMBER:
PPR-197

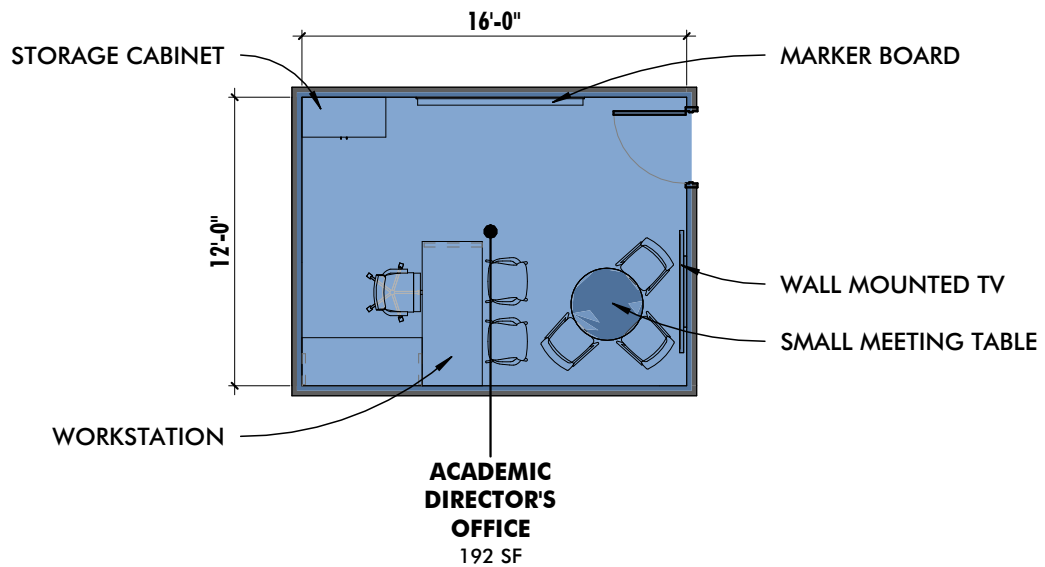

ACADEMIC DIRECTOR'S OFFICE
BALTIMORE POLICE DEPARTMENT
COPPIN STATE PUBLIC SAFETY BUILDING



10839-D PHILADELPHIA RD
WHITE MARSH, MD 21162
410-344-1460
INFO@MWSARCH.COM
WWW.MWSARCH.COM

JOB NO:22-002
DWG ISSUED ON:
09/27/2022
DWG SCALE:
1/8" = 1'-0"
DWG NUMBER:
PPR-198

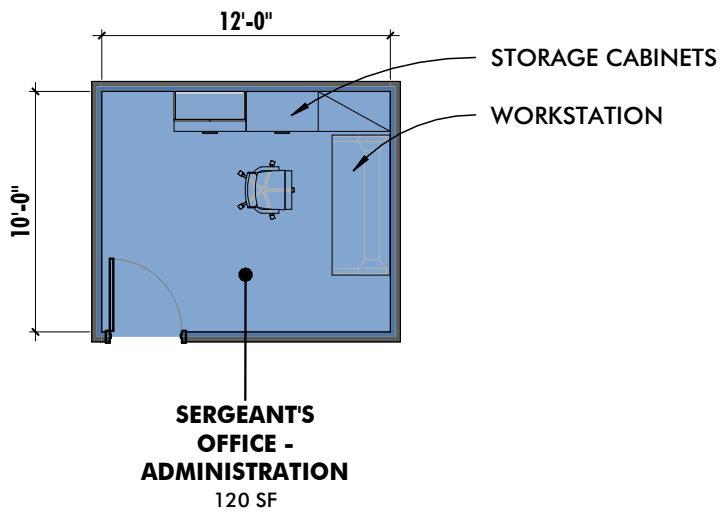

SERGEANT'S OFFICE - ADMINISTRATION
BALTIMORE POLICE DEPARTMENT
COPPIN STATE PUBLIC SAFETY BUILDING



10839-D PHILADELPHIA RD
 WHITE MARSH, MD 21162
 410-344-1460
 INFO@MWSARCH.COM
 WWW.MWSARCH.COM

JOB NO:22-002
 DWG ISSUED ON:
09/27/2022
 DWG SCALE:
1/8" = 1'-0"
 DWG NUMBER:
PPR-199

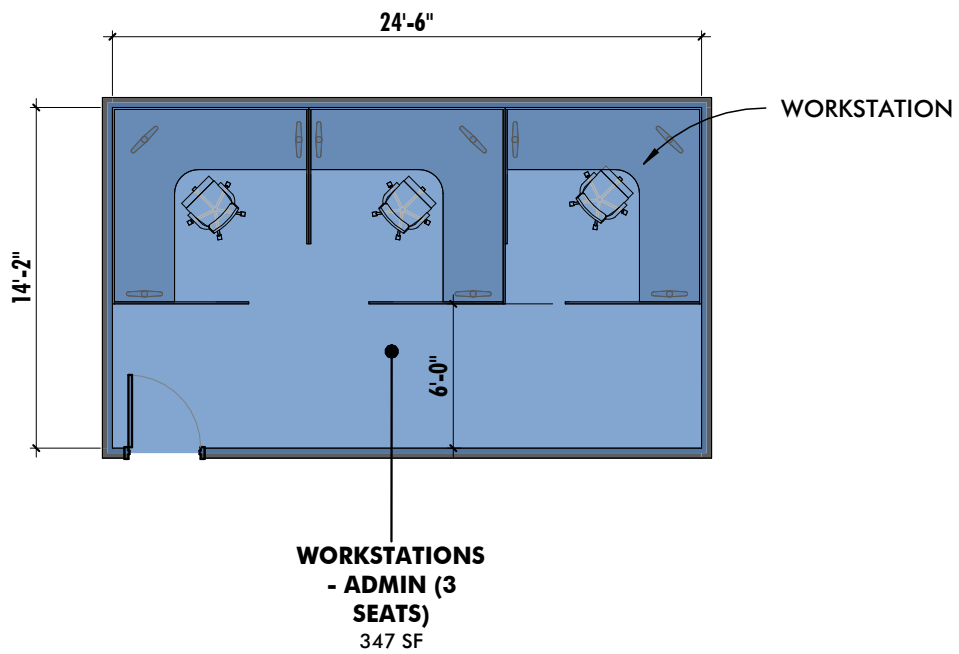

WORKSTATIONS - ADMINISTRATION
BALTIMORE POLICE DEPARTMENT
COPPIN STATE PUBLIC SAFETY BUILDING



10839-D PHILADELPHIA RD
 WHITE MARSH, MD 21162
 410-344-1460
 INFO@MWSARCH.COM
 WWW.MWSARCH.COM

JOB NO:22-002
DWG ISSUED ON:
09/27/2022
DWG SCALE:
1/8" = 1'-0"
DWG NUMBER:
PPR-200

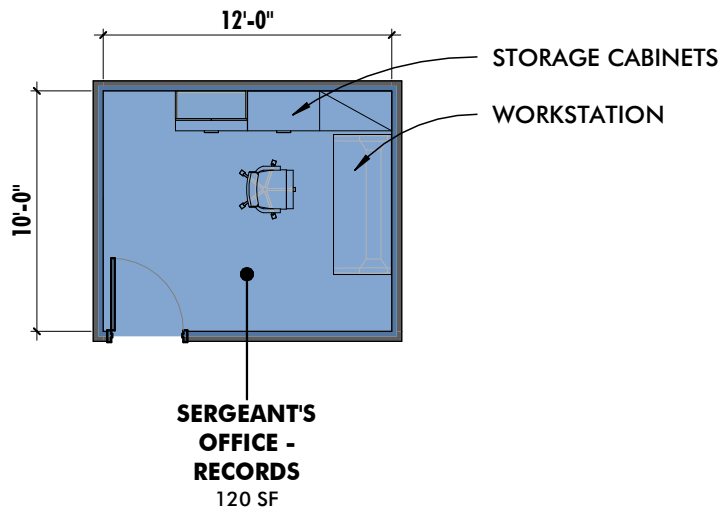

SERGEANT'S OFFICE - RECORDS

BALTIMORE POLICE DEPARTMENT

COPPIN STATE PUBLIC SAFETY BUILDING



10839-D PHILADELPHIA RD
WHITE MARSH, MD 21162

410-344-1460
INFO@MWSARCH.COM
WWW.MWSARCH.COM

JOB NO:22-002

DWG ISSUED ON:
09/27/2022

DWG SCALE:
1/8" = 1'-0"

DWG NUMBER:
PPR-201

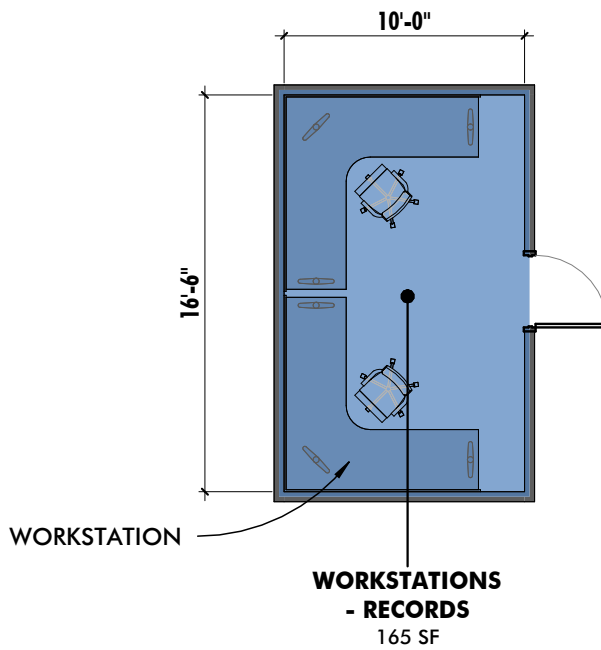

WORKSTATIONS - RECORDS

BALTIMORE POLICE DEPARTMENT

COPPIN STATE PUBLIC SAFETY BUILDING



10839-D PHILADELPHIA RD
WHITE MARSH, MD 21162

410-344-1460
INFO@MWSARCH.COM
WWW.MWSARCH.COM

JOB NO:22-002

DWG ISSUED ON:
09/27/2022

DWG SCALE:
1/8" = 1'-0"

DWG NUMBER:
PPR-202

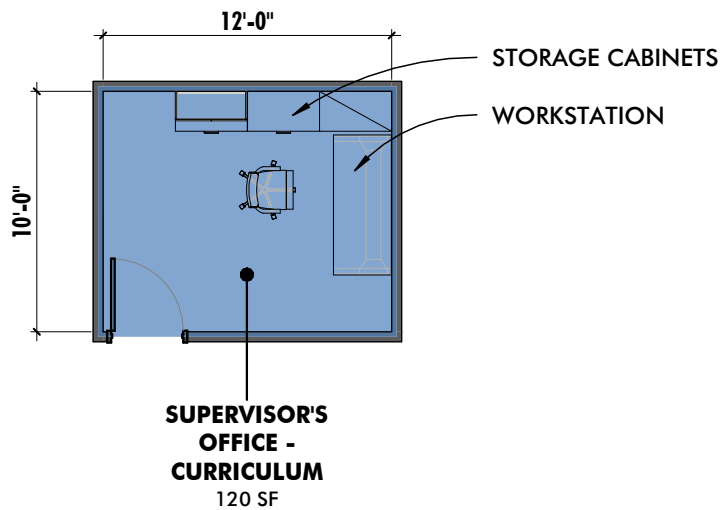

SUPERVISOR'S OFFICE - CURRICULUM

BALTIMORE POLICE DEPARTMENT

COPPIN STATE PUBLIC SAFETY BUILDING



10839-D PHILADELPHIA RD
WHITE MARSH, MD 21162

410-344-1460
INFO@MWSARCH.COM
WWW.MWSARCH.COM

JOB NO:22-002

DWG ISSUED ON:
09/27/2022

DWG SCALE:
1/8" = 1'-0"

DWG NUMBER:
PPR-203

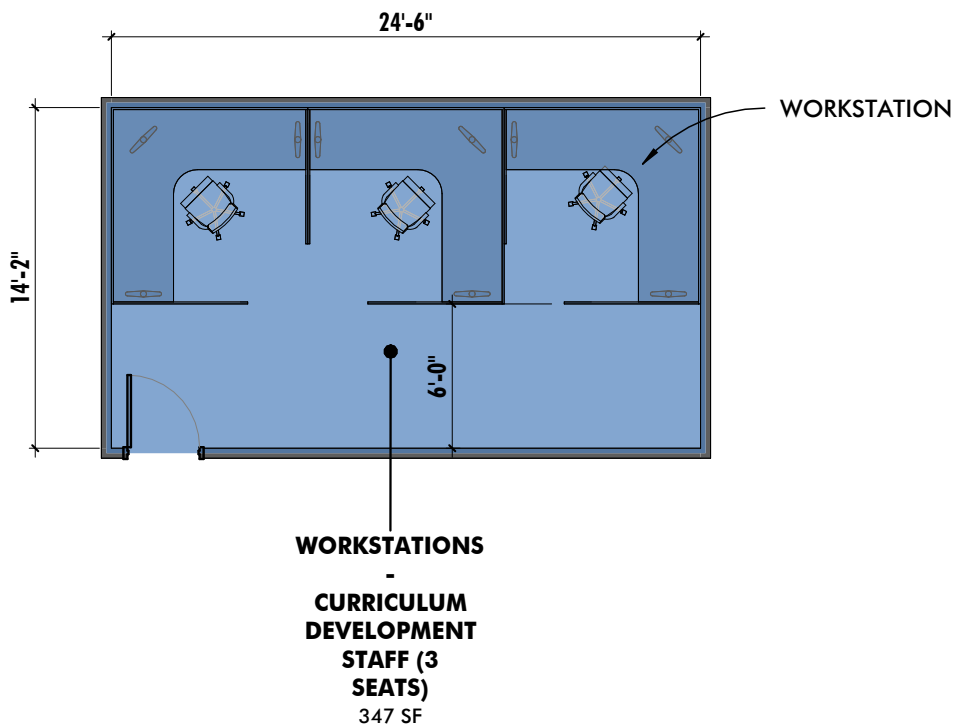

WORKSTATIONS - CURRICULUM DEV. STAFF
BALTIMORE POLICE DEPARTMENT
COPPIN STATE PUBLIC SAFETY BUILDING



10839-D PHILADELPHIA RD
 WHITE MARSH, MD 21162
 410-344-1460
 INFO@MWSARCH.COM
 WWW.MWSARCH.COM

JOB NO:22-002
DWG ISSUED ON:
09/27/2022
DWG SCALE:
1/8" = 1'-0"
DWG NUMBER:
PPR-204

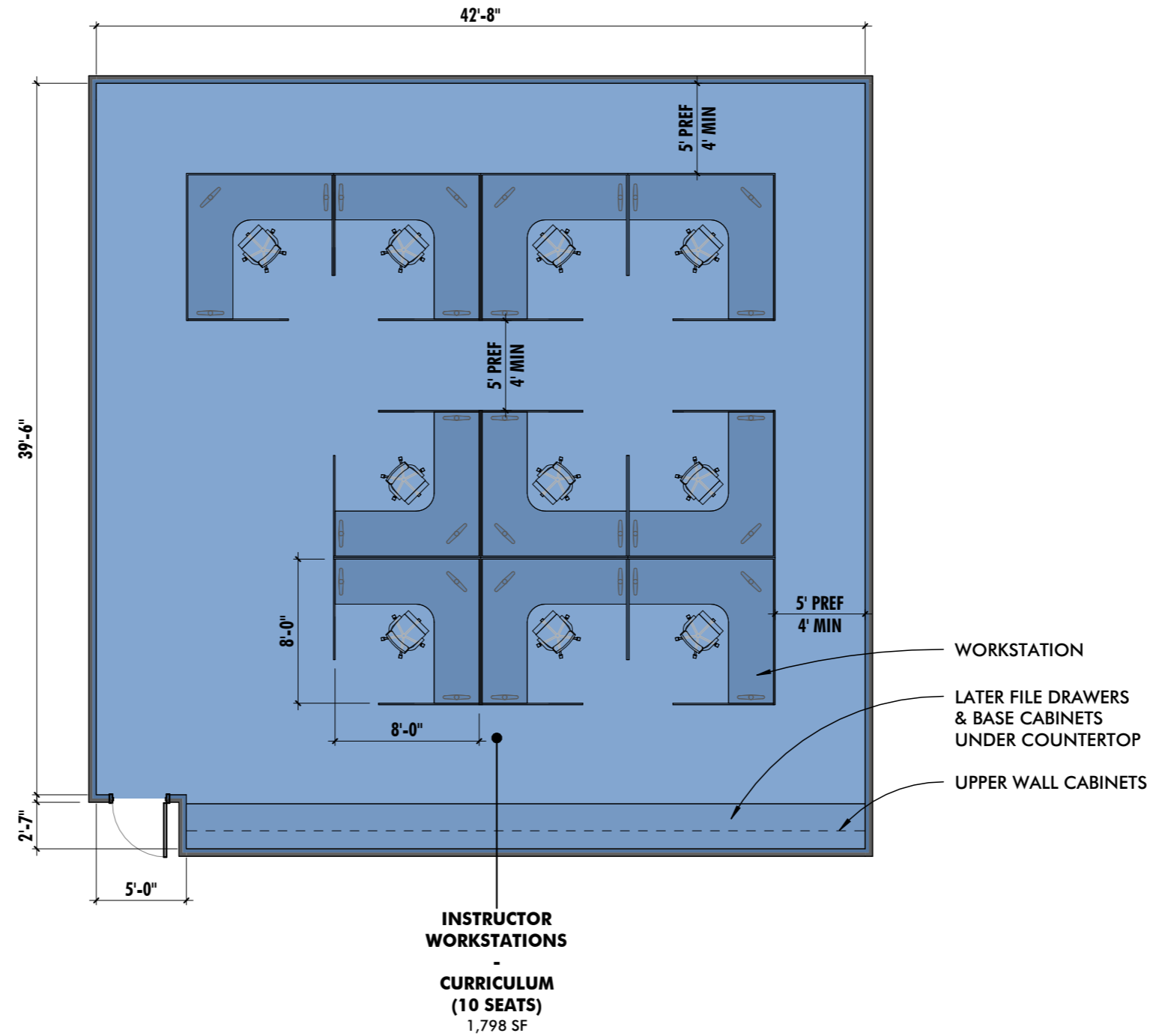

INSTRUCTOR WORKSTATIONS - CURRICULUM
BALTIMORE POLICE DEPARTMENT
COPPIN STATE PUBLIC SAFETY BUILDING



10839-D PHILADELPHIA RD
WHITE MARSH, MD 21162
410-344-1460
INFO@MWSARCH.COM
WWW.MWSARCH.COM

JOB NO:22-002

DWG ISSUED ON:
09/27/2022

DWG SCALE:
1/8" = 1'-0"

DWG NUMBER:
PPR-205

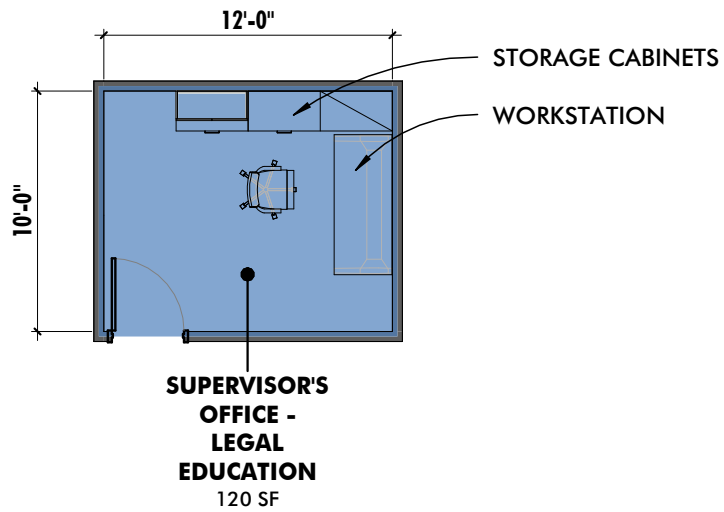

SUPERVISOR'S OFFICE - LEGAL EDUCATION
BALTIMORE POLICE DEPARTMENT
COPPIN STATE PUBLIC SAFETY BUILDING



10839-D PHILADELPHIA RD
 WHITE MARSH, MD 21162
 410-344-1460
 INFO@MWSARCH.COM
 WWW.MWSARCH.COM

JOB NO:22-002
DWG ISSUED ON:
09/27/2022
DWG SCALE:
1/8" = 1'-0"
DWG NUMBER:
PPR-206

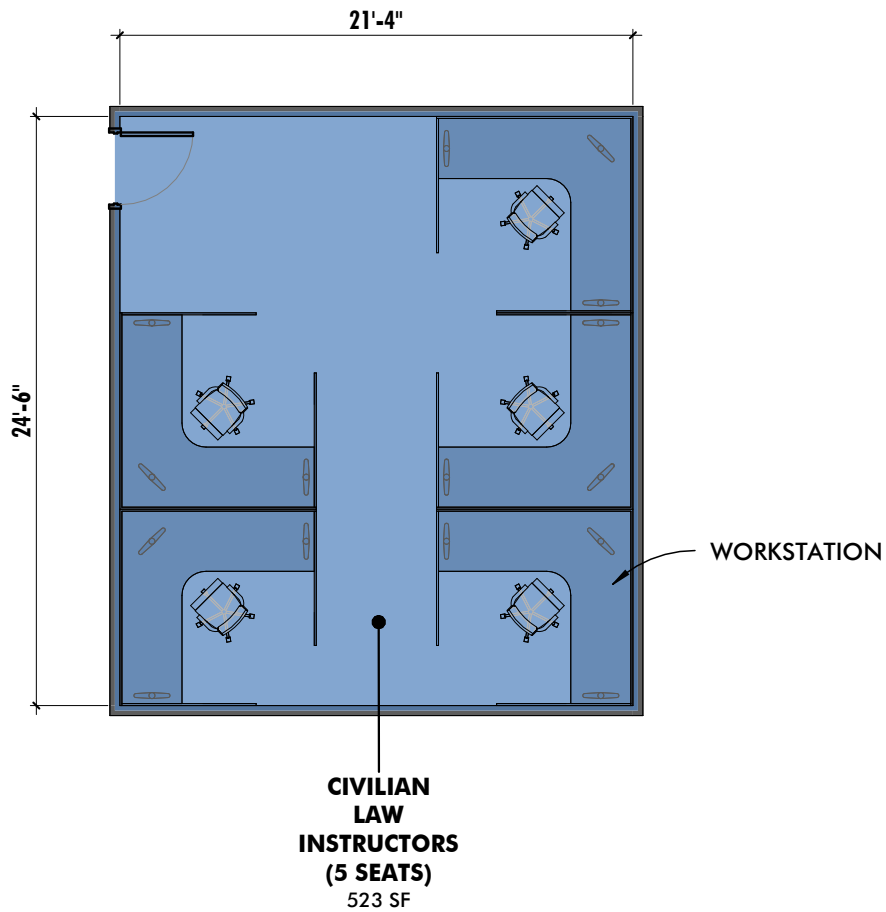

CIVILIAN LAW INSTRUCTORS
BALTIMORE POLICE DEPARTMENT
COPPIN STATE PUBLIC SAFETY BUILDING



10839-D PHILADELPHIA RD
 WHITE MARSH, MD 21162
 410-344-1460
 INFO@MWSARCH.COM
 WWW.MWSARCH.COM

JOB NO:22-002

**DWG ISSUED ON:
09/27/2022**

**DWG SCALE:
1/8" = 1'-0"**

**DWG NUMBER:
PPR-207**

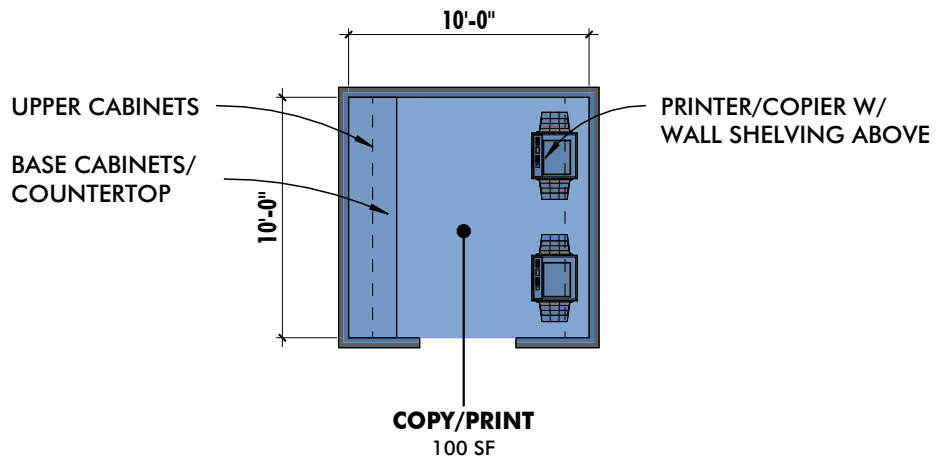

COPY/PRINT

**BALTIMORE POLICE DEPARTMENT
COPPIN STATE PUBLIC SAFETY BUILDING**



10839-D PHILADELPHIA RD
WHITE MARSH, MD 21162

410-344-1460
INFO@MWSARCH.COM
WWW.MWSARCH.COM

JOB NO:22-002

**DWG ISSUED ON:
09/27/2022**

**DWG SCALE:
1/8" = 1'-0"**

**DWG NUMBER:
PPR-208**

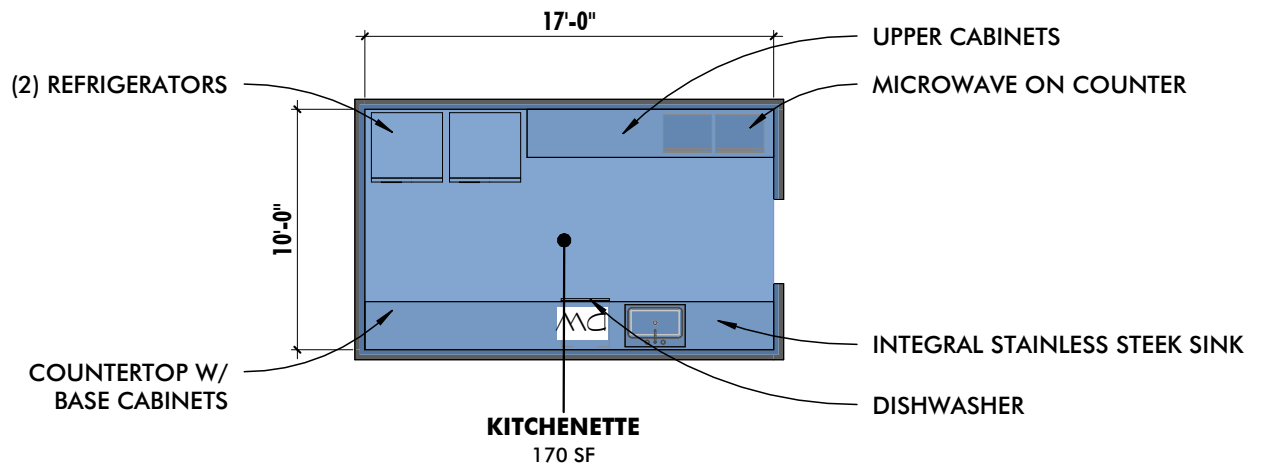

KITCHENETTE - ADMINISTRATION
BALTIMORE POLICE DEPARTMENT
COPPIN STATE PUBLIC SAFETY BUILDING



10839-D PHILADELPHIA RD
 WHITE MARSH, MD 21162
 410-344-1460
 INFO@MWSARCH.COM
 WWW.MWSARCH.COM

JOB NO:22-002
DWG ISSUED ON:
09/27/2022
DWG SCALE:
1/8" = 1'-0"
DWG NUMBER:
PPR-209

HIGH DENSITY
MOBILE STORAGE
SHELVING

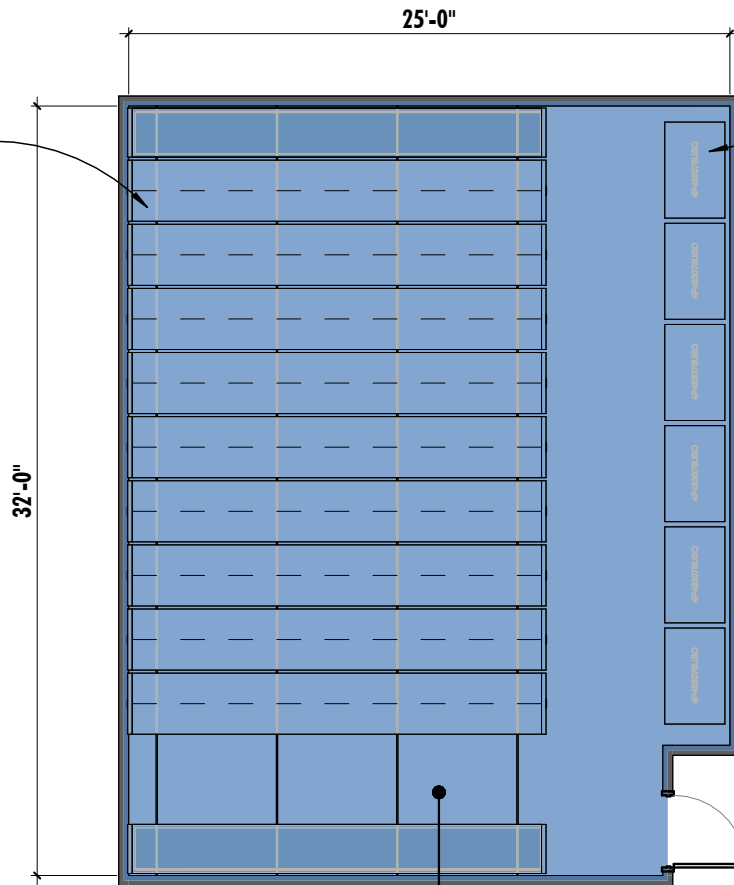

FOUR-POST
SHELVING

STORAGE -
TRAINING
RECORDS
785 SF

STORAGE - TRAINING RECORDS
BALTIMORE POLICE DEPARTMENT
COPPIN STATE PUBLIC SAFETY BUILDING



10839-D PHILADELPHIA RD
WHITE MARSH, MD 21162
410-344-1460
INFO@MWSARCH.COM
WWW.MWSARCH.COM

JOB NO:22-002
DWG ISSUED ON:
09/27/2022
DWG SCALE:
1/8" = 1'-0"
DWG NUMBER:
PPR-210

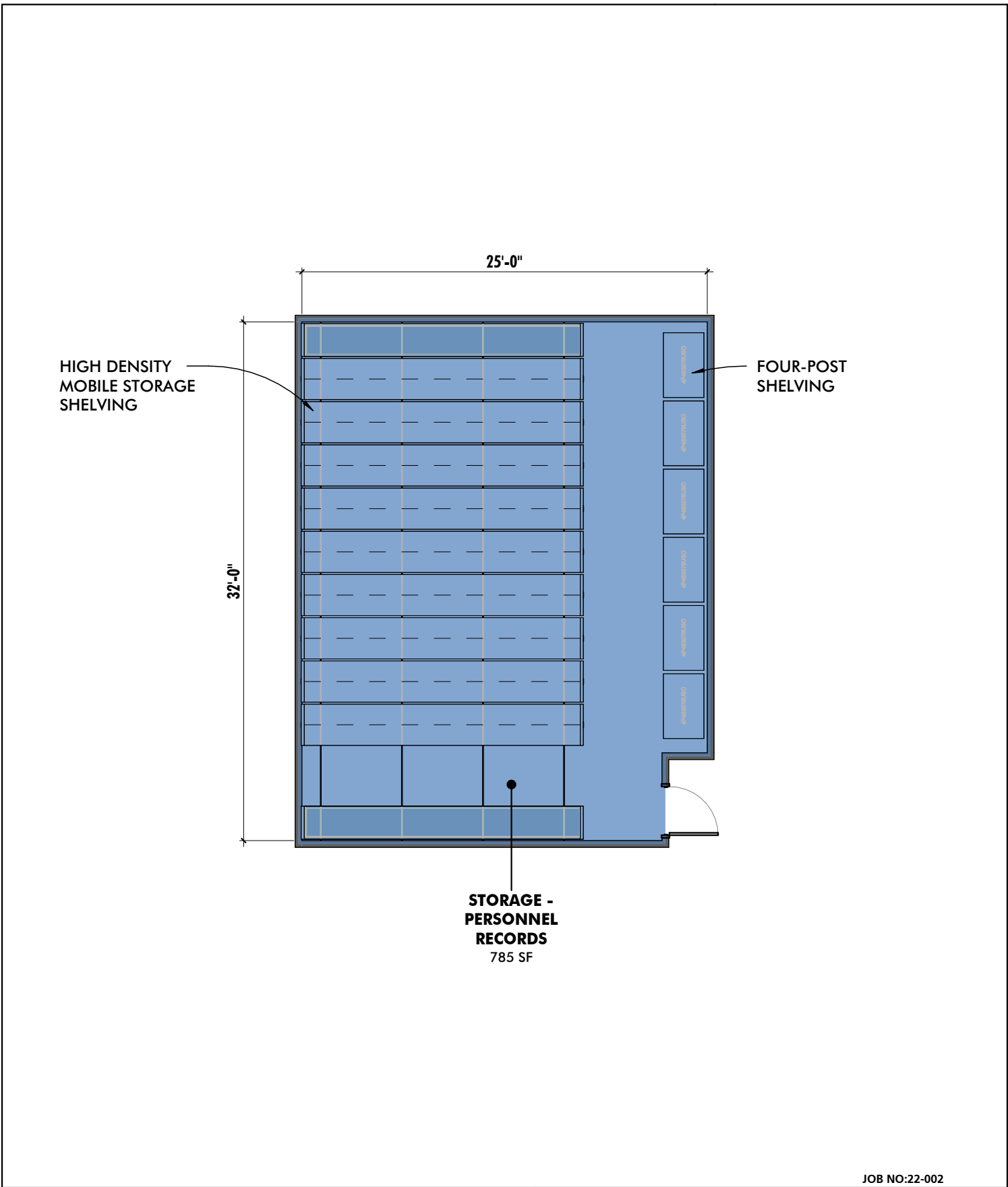

STORAGE - PERSONNEL RECORDS

BALTIMORE POLICE DEPARTMENT

COPPIN STATE PUBLIC SAFETY BUILDING



ARCHITECTURE + MASTER PLANNING

10839-D PHILADELPHIA RD
WHITE MARSH, MD 21162

410-344-1460
INFO@MWSARCH.COM
WWW.MWSARCH.COM

JOB NO:22-002

DWG ISSUED ON:
09/27/2022

DWG SCALE:
1/8" = 1'-0"

DWG NUMBER:
PPR-211

9/27/2022 8:23:31 AM

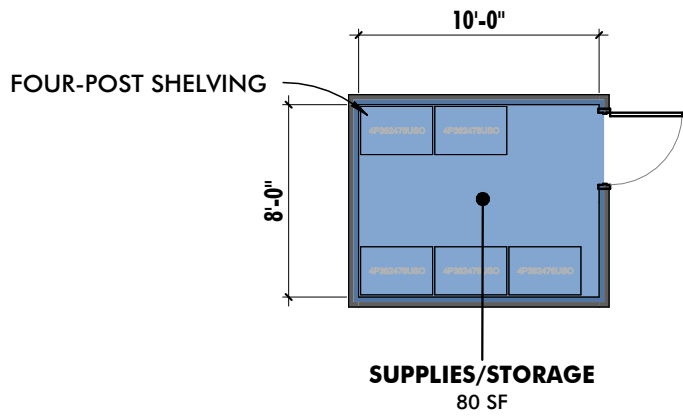

STORAGE - OFFICE SUPPLIES

BALTIMORE POLICE DEPARTMENT

COPPIN STATE PUBLIC SAFETY BUILDING



10839-D PHILADELPHIA RD
WHITE MARSH, MD 21162

410-344-1460
INFO@MWSARCH.COM
WWW.MWSARCH.COM

JOB NO:22-002

DWG ISSUED ON:
09/27/2022

DWG SCALE:
1/8" = 1'-0"

DWG NUMBER:
PPR-212

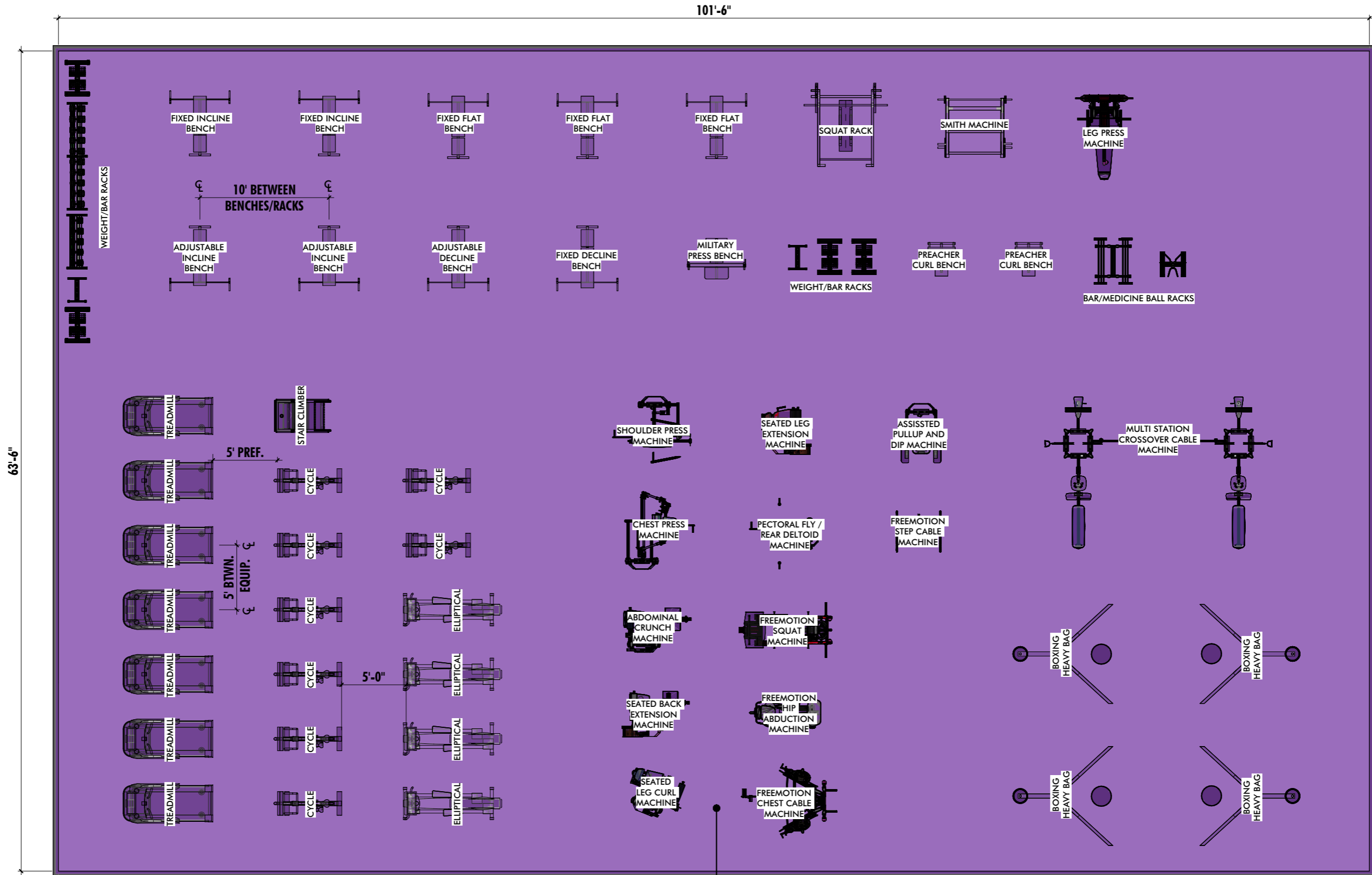

INDOOR FITNESS
6,445 SF

INDOOR FITNESS

COPPIN STATE PUBLIC SAFETY BUILDING

ALL DRAWINGS ARE COPYRIGHT 2018 BY MANNS WOODWARD STUDIOS, INC. AND CAN NOT BE REPRODUCED OR MODIFIED IN ANY MANNER WITHOUT WRITTEN PERMISSION

MANN
STUDIOS
ARCHITECTURE + MASTER PLANNING

10839-D PHILADELPHIA RD
WHITE MARSH, MD 21162

410-344-1460
INFO@MWSARCH.COM
WWW.MWSARCH.COM

JOB NO:22-002

DWG ISSUED ON:
09/14/2022

DWG SCALE:
1/8" = 1'-0"

DWG NUMBER:
SPR-001

9/13/2022 1:01:55 PM

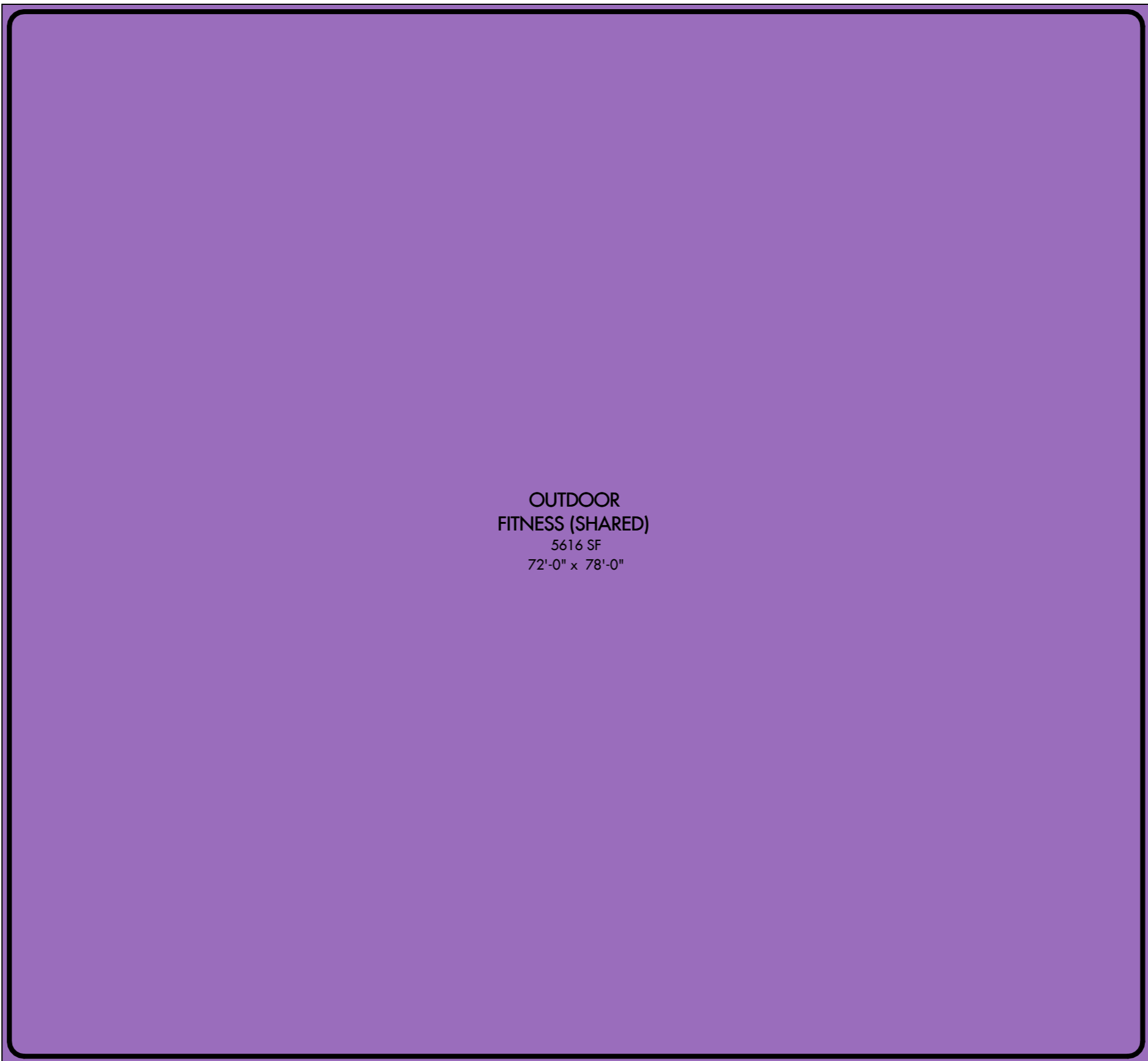

OUTDOOR
FITNESS (SHARED)
5616 SF
72'-0" x 78'-0"

OUTDOOR FITNESS

COPPIN STATE PUBLIC SAFETY BUILDING

JOB NO:22-002

DWG ISSUED ON:
09/14/2022

DWG SCALE:
1/8" = 1'-0"

DWG NUMBER:
SPR-002



10839-D PHILADELPHIA RD
WHITE MARSH, MD 21162
410-344-1460
INFO@MWSARCH.COM
WWW.MWSARCH.COM

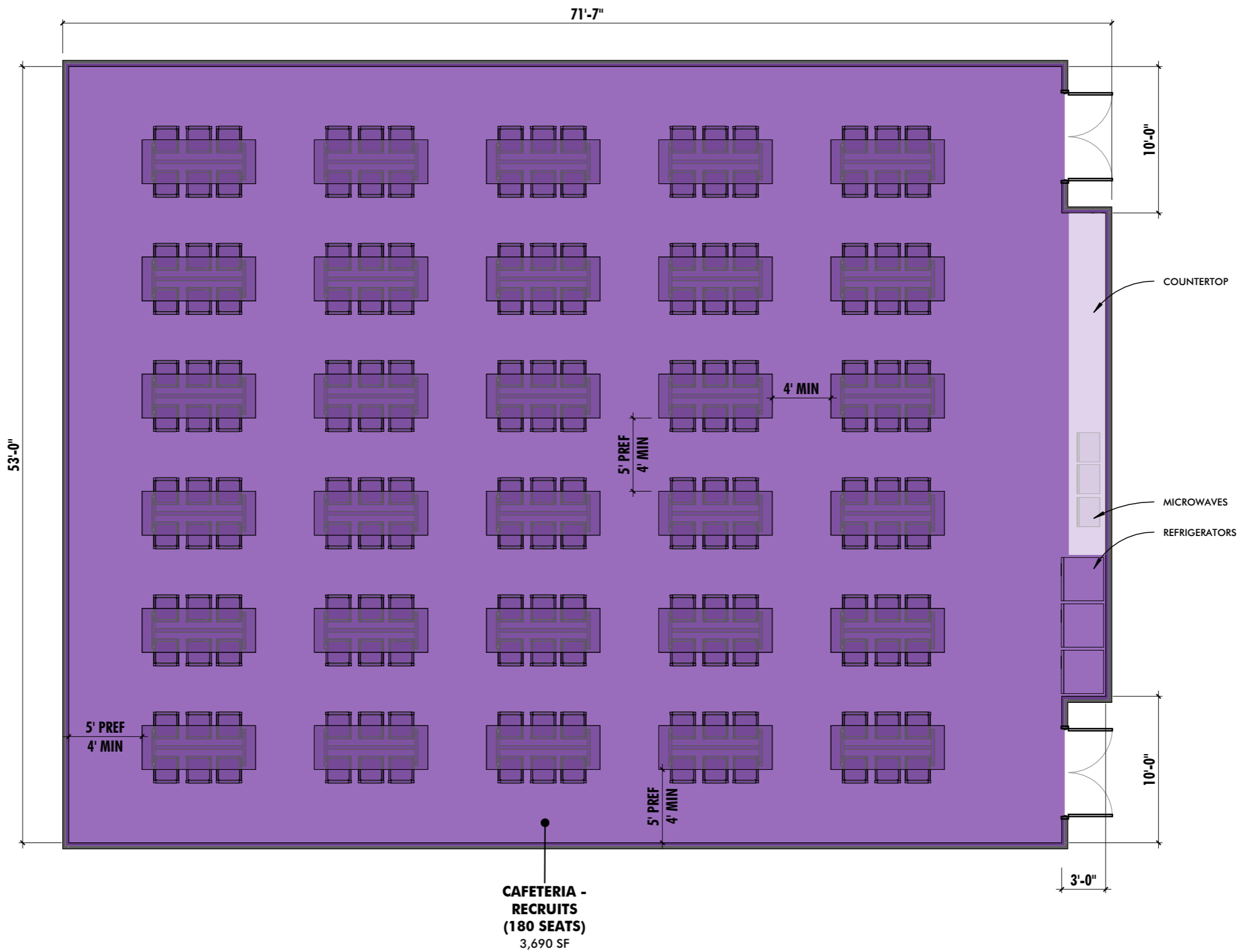

CAFETERIA (RECRUITS)

COPPIN STATE PUBLIC SAFETY BUILDING

JOB NO:22-002

DWG ISSUED ON:
09/14/2022

DWG SCALE:
1/8" = 1'-0"

DWG NUMBER:
SPR-008



10839-D PHILADELPHIA RD
WHITE MARSH, MD 21162
410-344-1460
INFO@MWSARCH.COM
WWW.MWSARCH.COM

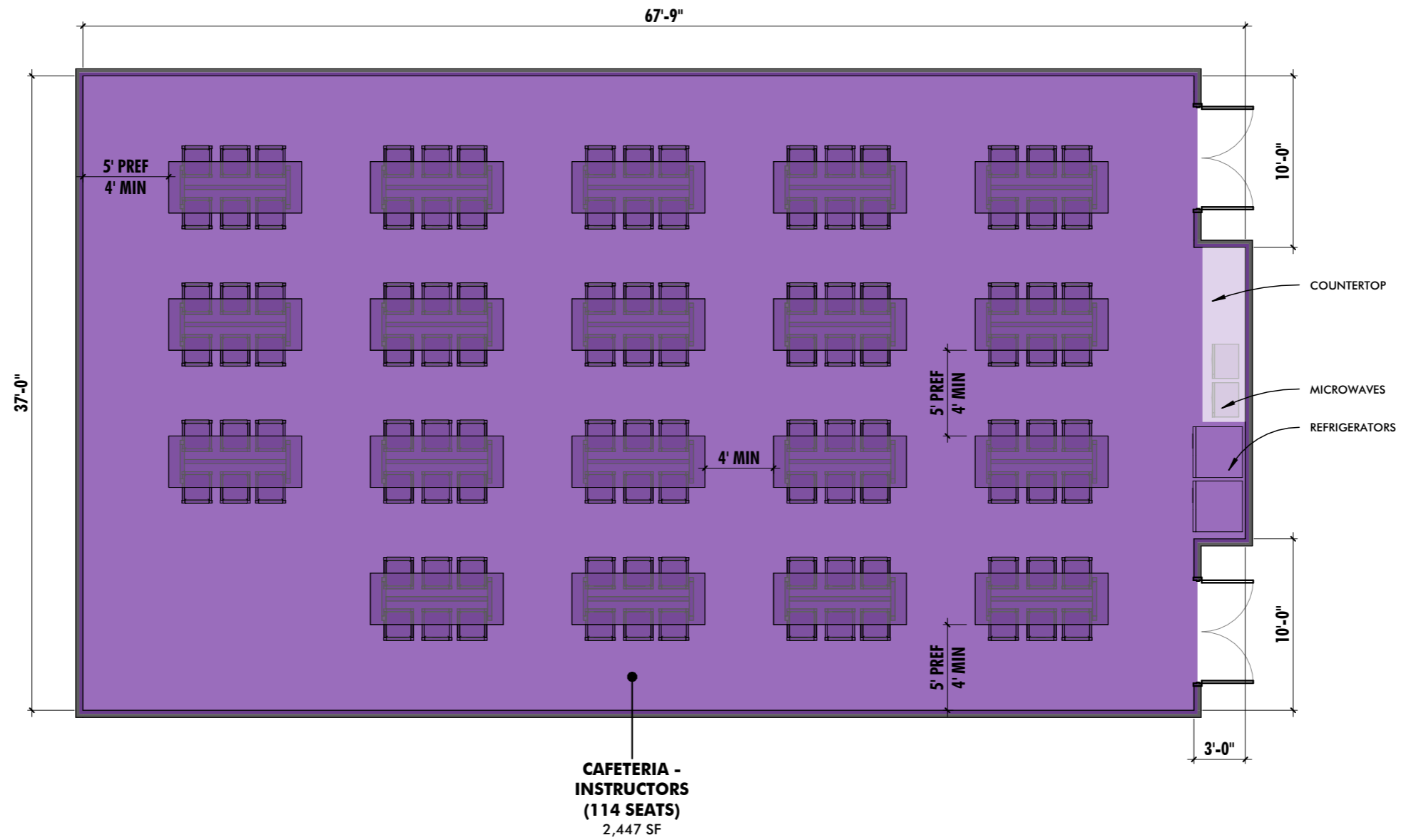

CAFETERIA (INSTRUCTORS)

COPPIN STATE PUBLIC SAFETY BUILDING

JOB NO:22-002

DWG ISSUED ON:
09/14/2022

DWG SCALE:
1/8" = 1'-0"

DWG NUMBER:
SPR-009



10839-D PHILADELPHIA RD
WHITE MARSH, MD 21162
410-344-1460
INFO@MWSARCH.COM
WWW.MWSARCH.COM



CANTEEN

COPPIN STATE PUBLIC SAFETY BUILDING

JOB NO:22-002

DWG ISSUED ON:
09/14/2022

DWG SCALE:
1/8" = 1'-0"

DWG NUMBER:
SPR-010



10839-D PHILADELPHIA RD
WHITE MARSH, MD 21162
410-344-1460
INFO@MWSARCH.COM
WWW.MWSARCH.COM

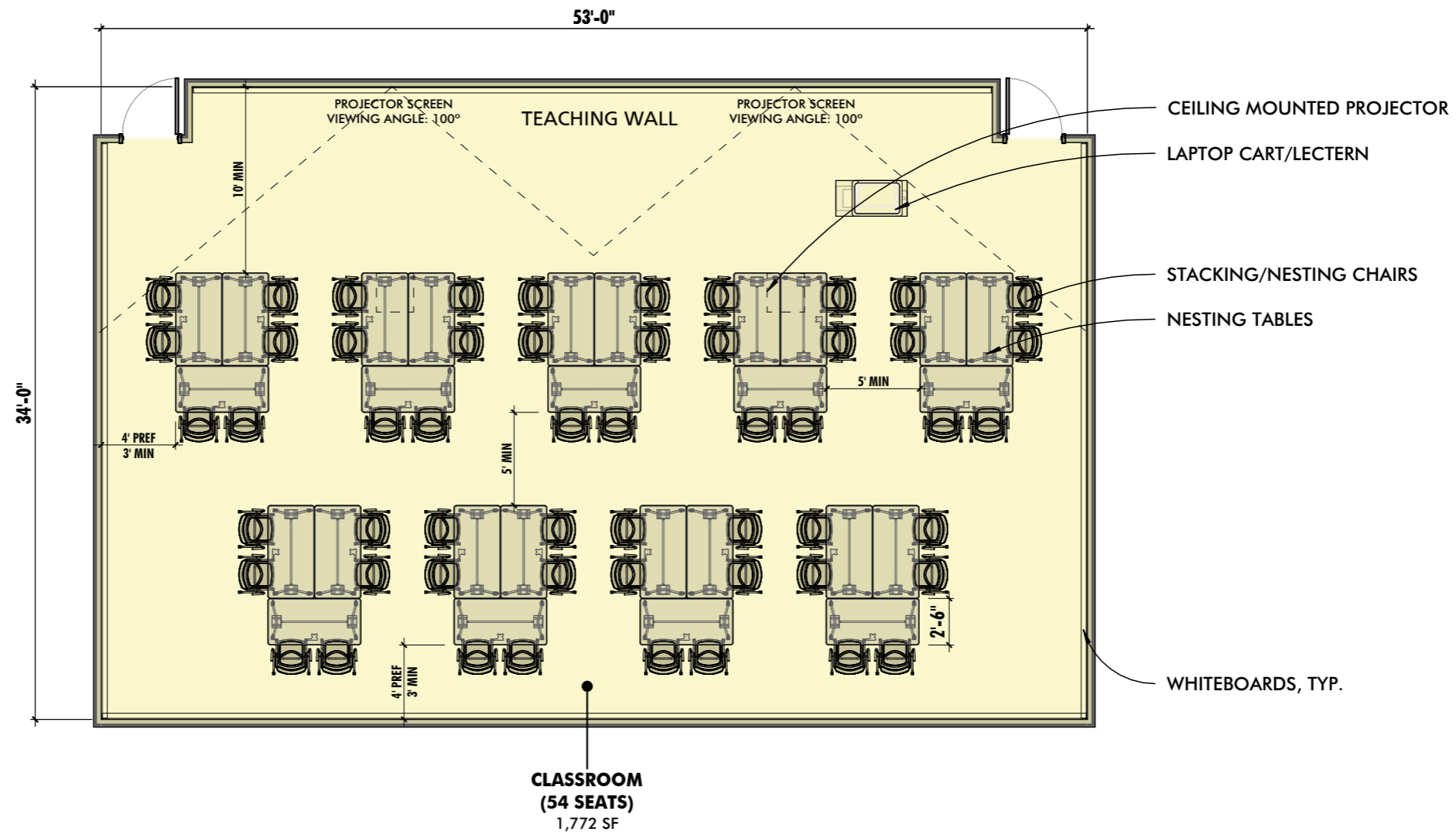

CLASSROOM (54 PERSON)
CRIMINAL JUSTICE INSTITUTE
COPPIN STATE PUBLIC SAFETY BUILDING



10839-D PHILADELPHIA RD
 WHITE MARSH, MD 21162
 410-344-1460
 INFO@MWSARCH.COM
 WWW.MWSARCH.COM

JOB NO:22-002
 DWG ISSUED ON:
09/27/2022
 DWG SCALE:
 1/8" = 1'-0"
 DWG NUMBER:
CPR-001

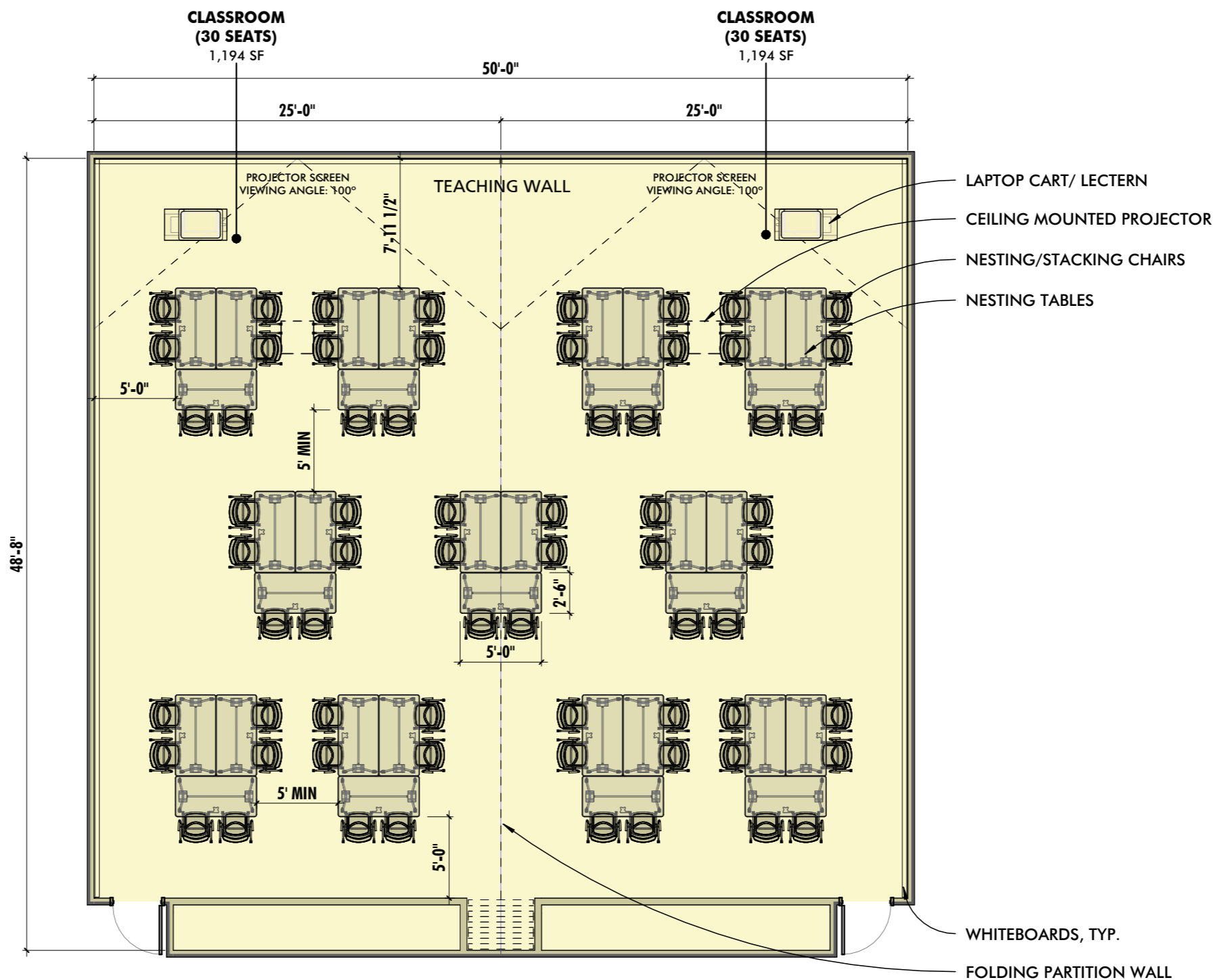

FLEX CLASSROOM (30/65 PERSON)
CRIMINAL JUSTICE INSTITUTE
COPPIN STATE PUBLIC SAFETY BUILDING



10839-D PHILADELPHIA RD
 WHITE MARSH, MD 21162
 410-344-1460
 INFO@MWSARCH.COM
 WWW.MWSARCH.COM

JOB NO:22-002

DWG ISSUED ON:
09/27/2022

DWG SCALE:
1/8" = 1'-0"

DWG NUMBER:
CPR-002

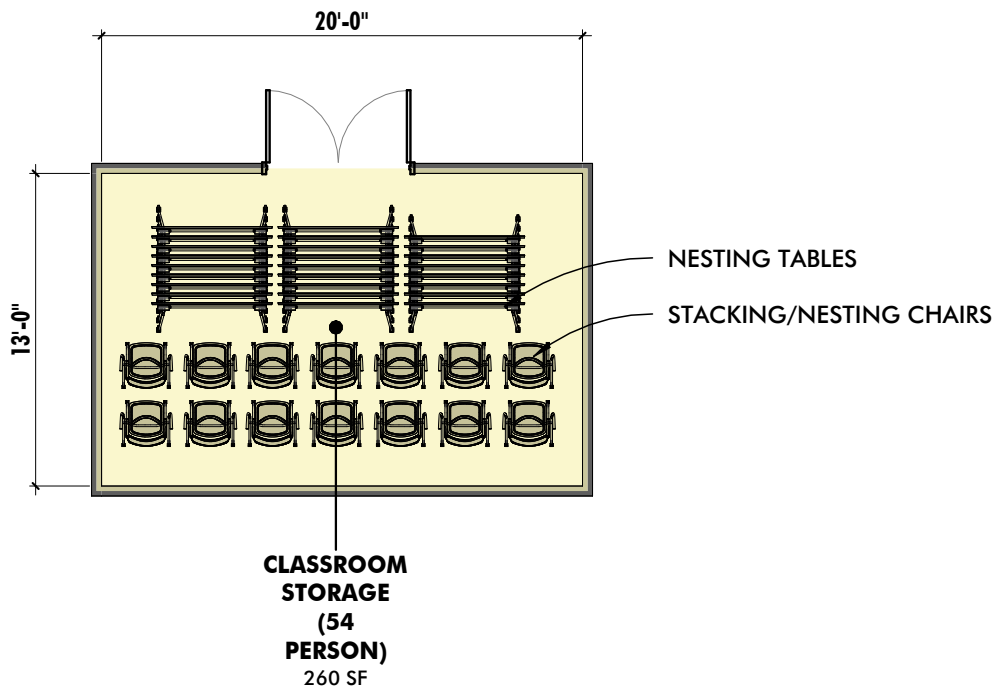

CLASSROOM STORAGE - 54 SEATS

CRIMINAL JUSTICE INSTITUTE

COPPIN STATE PUBLIC SAFETY BUILDING



10839-D PHILADELPHIA RD
WHITE MARSH, MD 21162

410-344-1460
INFO@MWSARCH.COM
WWW.MWSARCH.COM

JOB NO:22-002

DWG ISSUED ON:
09/27/2022

DWG SCALE:
1/8" = 1'-0"

DWG NUMBER:
CPR-003

10/27/2022 4:18:00 PM

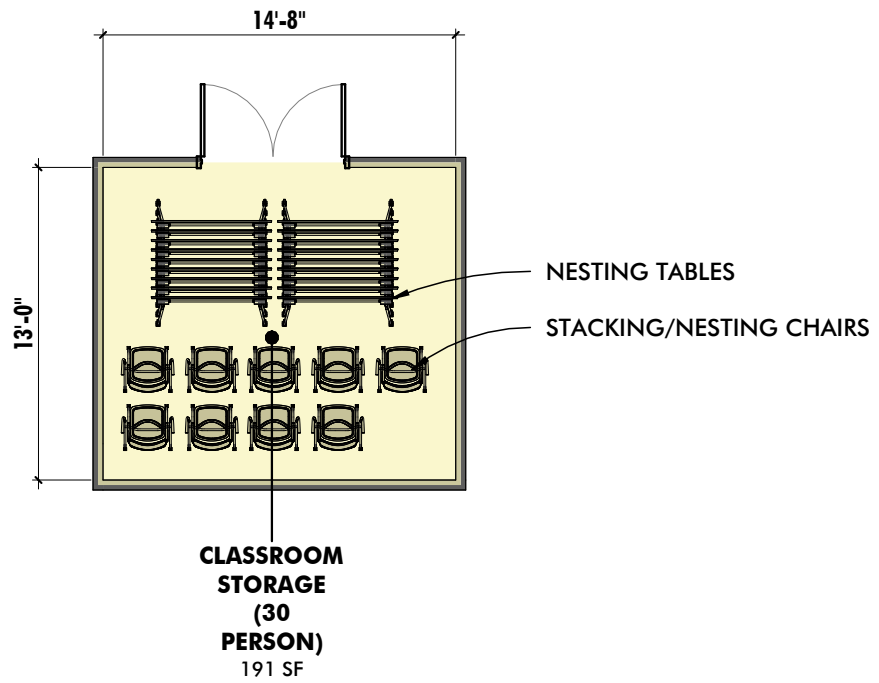

CLASSROOM STORAGE - 30 SEATS

CRIMINAL JUSTICE INSTITUTE

COPPIN STATE PUBLIC SAFETY BUILDING



10839-D PHILADELPHIA RD
WHITE MARSH, MD 21162

410-344-1460
INFO@MWSARCH.COM
WWW.MWSARCH.COM

JOB NO:22-002

DWG ISSUED ON:
09/27/2022

DWG SCALE:
1/8" = 1'-0"

DWG NUMBER:
CPR-004

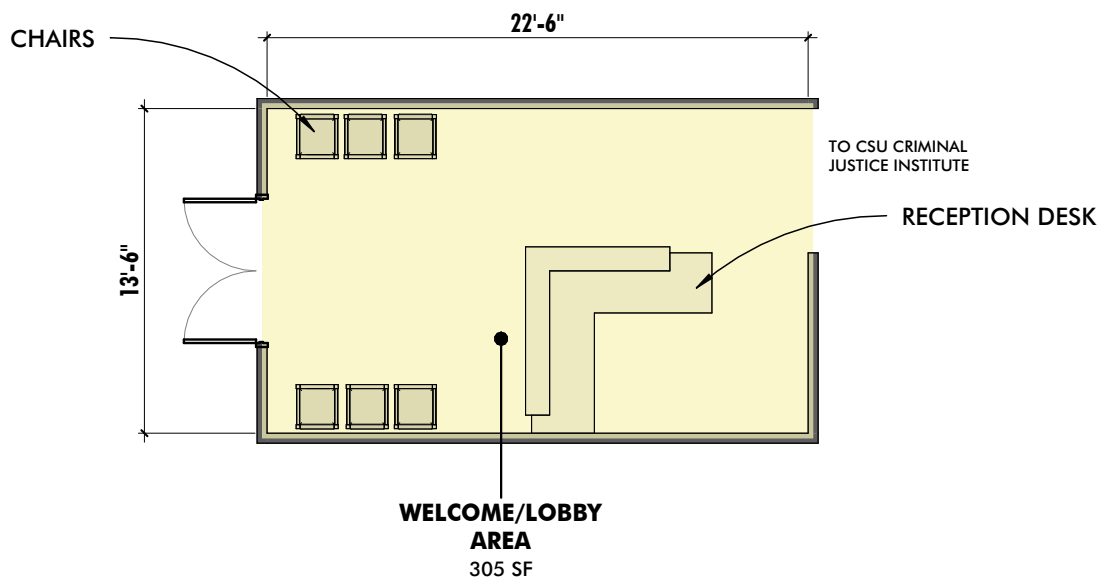

WELCOME/LOBBY AREA

CRIMINAL JUSTICE INSTITUTE

COPPIN STATE PUBLIC SAFETY BUILDING



10839-D PHILADELPHIA RD
WHITE MARSH, MD 21162

410-344-1460
INFO@MWSARCH.COM
WWW.MWSARCH.COM

JOB NO:22-002

DWG ISSUED ON:
09/27/2022

DWG SCALE:
1/8" = 1'-0"

DWG NUMBER:
CPR-015

10/27/2022 4:18:39 PM

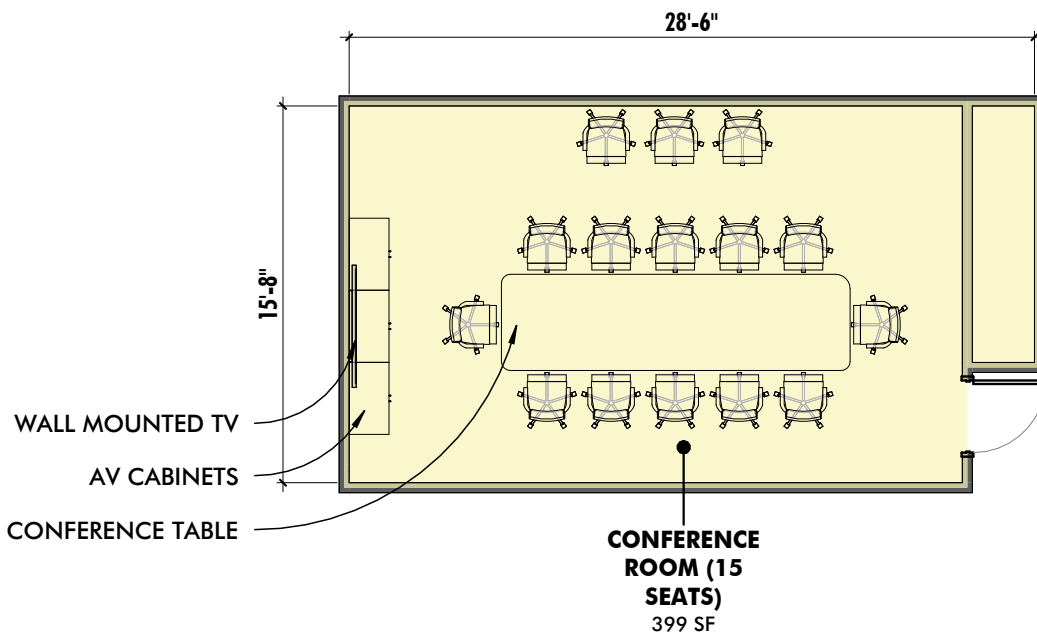

CONFERENCE ROOM

CRIMINAL JUSTICE INSTITUTE

COPPIN STATE PUBLIC SAFETY BUILDING



10839-D PHILADELPHIA RD
WHITE MARSH, MD 21162

410-344-1460
INFO@MWSARCH.COM
WWW.MWSARCH.COM

JOB NO:22-002

DWG ISSUED ON:
09/27/2022

DWG SCALE:
1/8" = 1'-0"

DWG NUMBER:
CPR-016

10/27/2022 4:18:40 PM

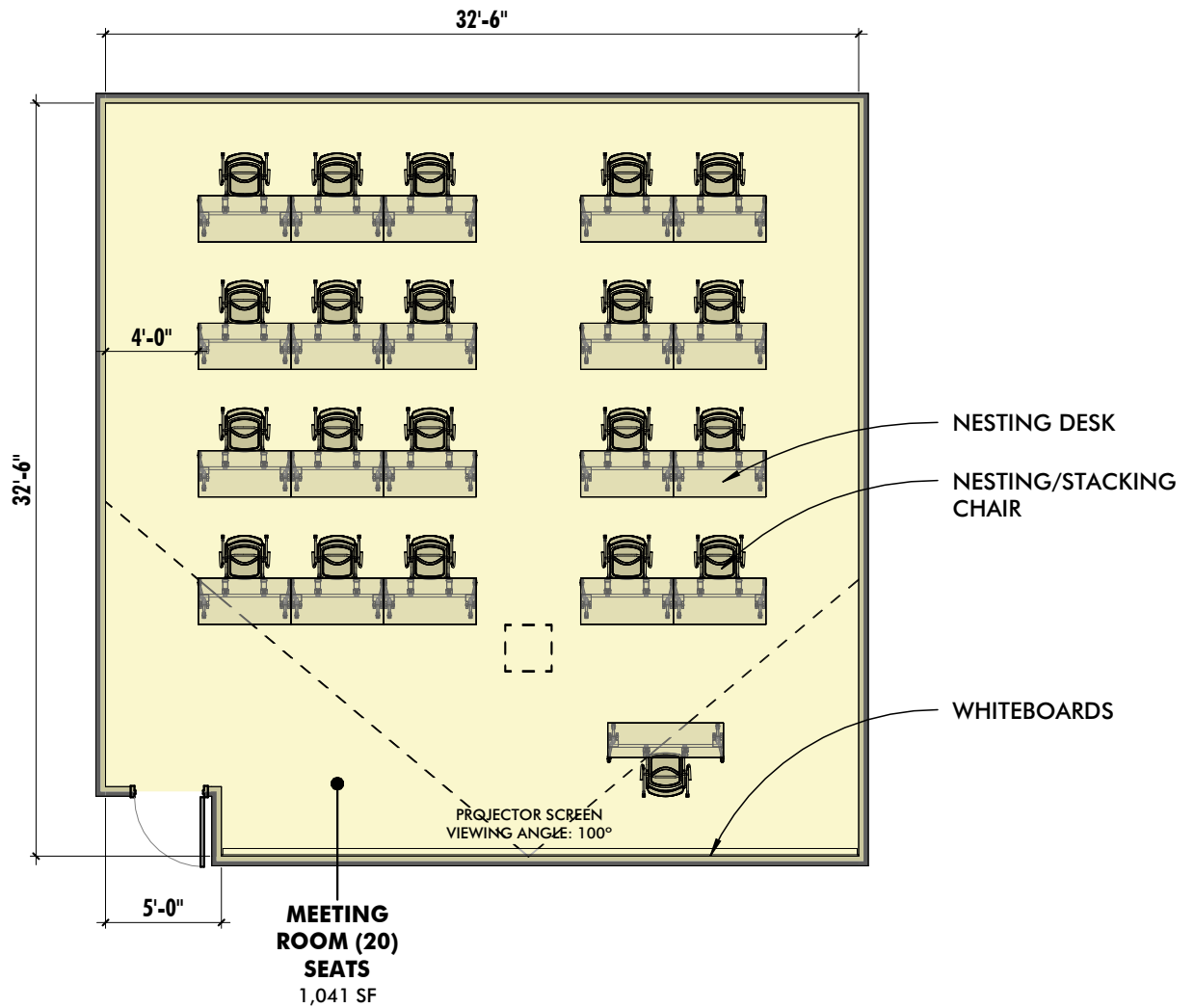

MEETING ROOM

CRIMINAL JUSTICE INSTITUTE

COPPIN STATE PUBLIC SAFETY BUILDING



10839-D PHILADELPHIA RD
WHITE MARSH, MD 21162

410-344-1460
INFO@MWSARCH.COM
WWW.MWSARCH.COM

JOB NO:22-002

**DWG ISSUED ON:
09/27/2022**

**DWG SCALE:
1/8" = 1'-0"**

**DWG NUMBER:
CPR-017**

10/27/2022 4:19:41 PM

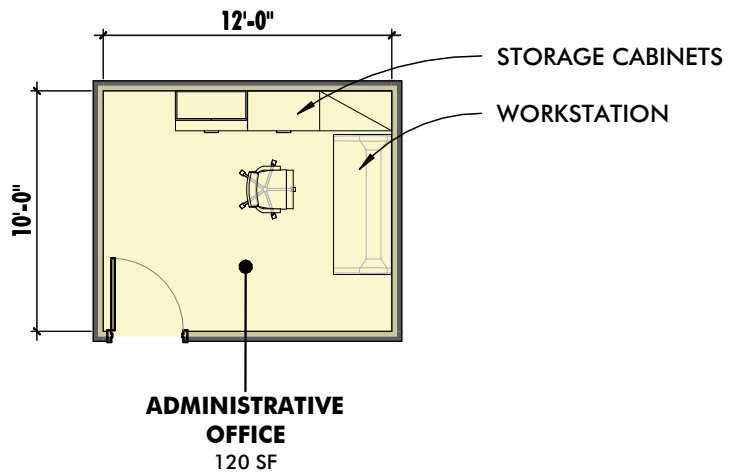

ADMINISTRATIVE OFFICE

CRIMINAL JUSTICE INSTITUTE

COPPIN STATE PUBLIC SAFETY BUILDING



10839-D PHILADELPHIA RD
WHITE MARSH, MD 21162

410-344-1460
INFO@MWSARCH.COM
WWW.MWSARCH.COM

JOB NO:22-002

DWG ISSUED ON:
09/27/2022

DWG SCALE:
1/8" = 1'-0"

DWG NUMBER:
CPR-018

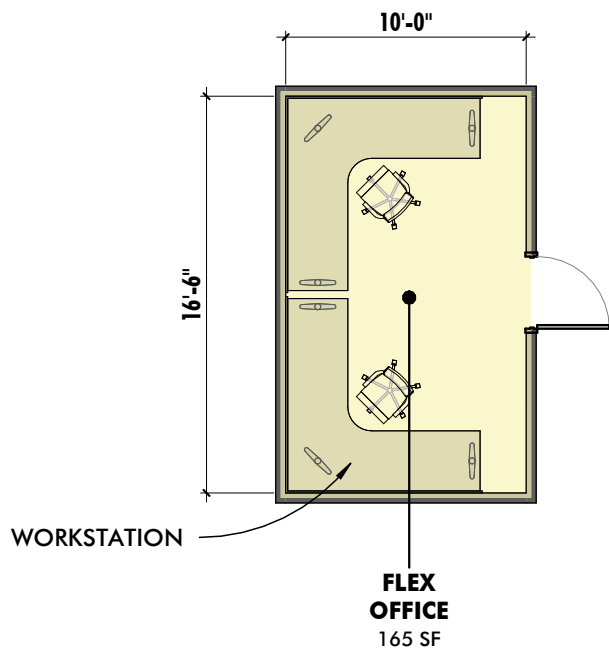

FLEX OFFICE

CRIMINAL JUSTICE INSTITUTE

COPPIN STATE PUBLIC SAFETY BUILDING



10839-D PHILADELPHIA RD
WHITE MARSH, MD 21162

410-344-1460
INFO@MWSARCH.COM
WWW.MWSARCH.COM

JOB NO:22-002

DWG ISSUED ON:
09/27/2022

DWG SCALE:
1/8" = 1'-0"

DWG NUMBER:
CPR-019

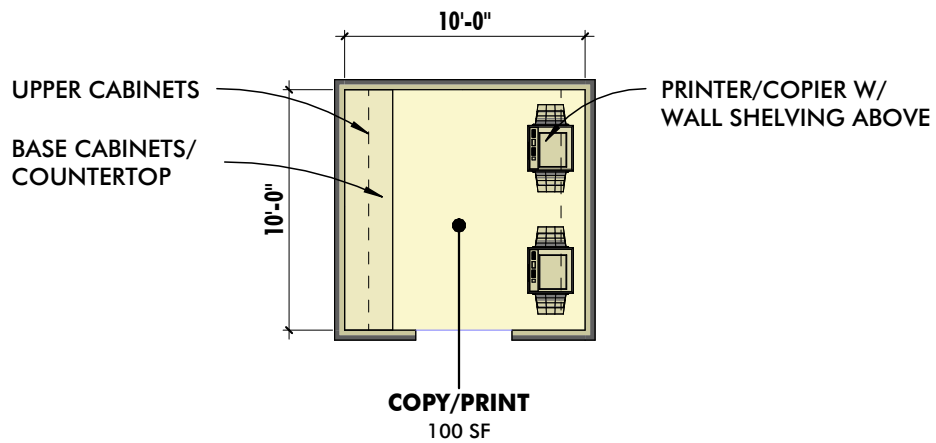

COPY/PRINT

**CRIMINAL JUSTICE INSTITUTE
COPPIN STATE PUBLIC SAFETY BUILDING**



10839-D PHILADELPHIA RD
WHITE MARSH, MD 21162

410-344-1460
INFO@MWSARCH.COM
WWW.MWSARCH.COM

JOB NO:22-002

**DWG ISSUED ON:
09/27/2022**

**DWG SCALE:
1/8" = 1'-0"**

**DWG NUMBER:
CPR-020**

10/27/2022 4:19:42 PM

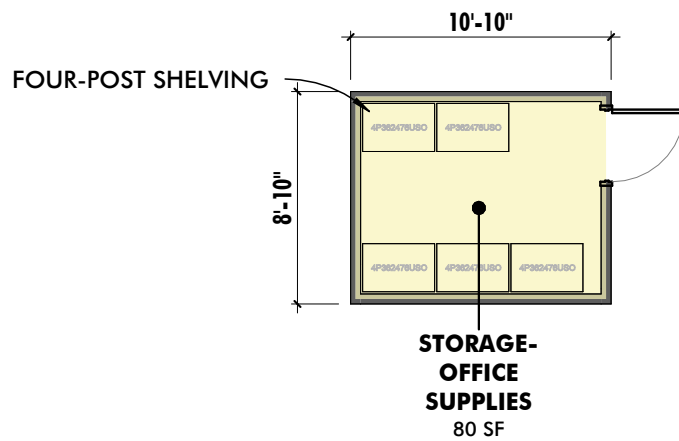

STORAGE - OFFICE SUPPLIES
CRIMINAL JUSTICE INSTITUTE
COPPIN STATE PUBLIC SAFETY BUILDING



10839-D PHILADELPHIA RD
 WHITE MARSH, MD 21162
 410-344-1460
 INFO@MWSARCH.COM
 WWW.MWSARCH.COM

JOB NO:22-002
DWG ISSUED ON:
09/27/2022
DWG SCALE:
1/8" = 1'-0"
DWG NUMBER:
CPR-021